

# 2. Graduiertentagung

## 2<sup>nd</sup> Graduate Symposium

5. November 2009





2. Graduiertentagung der FH Aachen

5. November 2009

2<sup>nd</sup> Graduate Symposium

FH Aachen – University of Applied Sciences

November 5<sup>th</sup>, 2009

# Inhaltsverzeichnis / Index

<b>Beiträge / Papers</b>	<b>5</b>
<b>Vorwort / Preface</b>	
Prof. Dr. Christiane Vaeßen Prof. Dr. Michael J. Schöning	7
<b>Curricula Vitae und Auszeichnungen / Awards</b>	
Prof. Dr. Andreas Offenhäusser Prof. Dr. Rainer Fischer	8 9
<b>Curricula Vitae und Exposés</b>	
El-Hussiny Aboulnaga, M.Sc.	10
Maryam Hadji Abouzar, M.Sc.	12
Dipl.-Ing. Matthias Bäcker	14
Rasha Bassam, M.Sc.	16
Frank Berretz, M.Sc.	18
Dipl.-Ing. Matthias Betsch, M.Sc.	20
Dipl.-Ing. Sebastian Börner, MBA	22
Minh Tuấn Dương, M.Sc., M.Eng.	24
Dipl.-Ing. Simone Groebel	26
Dipl.-Ing. Daniel Heinze	28
Dipl.-Ing. Patrick Kirchner	30
Dipl.-Ing. Silvia Kowollik	32
Eylem Kurulgan Demirci, M.Sc.	34
Dipl.-Ing. Nicole Lawrenz	36
Dipl.-Ing. Peter Linder, M.Sc.	38
Hakan Oflaz, M.Sc.	40
Dipl.-Ing. Oliver Pack	42
Phú Tinh Phạm, M.Eng.	44
Markus Raue, M.Sc.	46
Dipl.-Ing. Steffen Reisert	48
Dipl.-Ing. Alexander Edward Robinson	50
Dipl.-Ing. Markus Rusack	52
Sascha Skorupa, M.Sc.	54
Dipl.-Ing. Nils Elias Thenent	56
Dipl.-Ing. Monika Turek	58
Dipl.-Ing. Carl Frederik Werner	60
<b>Impressum / Imprint</b>	<b>62</b>

## Beiträge / Papers

<b>Autor / Author</b>	<b>Titel / Title</b>	<b>Seite / Page</b>
E. Aboulnaga	Cloning and expression of clostridium difficile butyrate synthetic genes in Escherichia coli	11
M.H. Abouzar	Detection of adsorption and binding of charged macromolecules by means of semiconductor field-effect devices	13
M. Bäcker	Modular solid-state sensor system for cell-culture process development	15
R. Bassam	Effect of nitric oxide on protein thermal stability	17
F. Berretz	XML-based history tracing in an actor-driven grid-enabled workflow system	19
M. Betsch	Decentralised stream production of biomass by coupling of a stationary fluidised bed combustion with an externally fired microgasturbine	21
S. Börner	Low NO <sub>x</sub> hydrogen fuelled gas turbine	23
M. T. Dư <sup>o</sup> ng	Modellierung des Schneidens von weichen Geweben für die interaktive VR-basierte medizinische Simulation	25
S. Groebel	Bio-LAPS – optimising of the operation of a biogas fermenter by means of a field-effect biosensor based on a light-addressable potentiometric sensor (LAPS)	27
D. Heinze	Synthesis of exfoliated polyvinyl acetate-layered silicate nanocomposites and their characterisation with respect to the barrier properties	29
P. Kirchner	Calorimetric sensor system based on RFID for H <sub>2</sub> O <sub>2</sub> monitoring in aseptic filling processes	31
S. Kowollik	Relevance of the respiratory quotient in mammalian cell culture fermentation	33
E. Kurulgan Demirci	Contractile tension of endothelial cells and beating cardiomyocytes: an LPS based in-vitro sepsis model	35
N. Lawrenz	Biomarker for prognosis of premature birth – a biomedical approach –	37
P. Linder	HP bioforce	39
H. Oflaz	Mechanics and structure of amniotic sac tissue as potential information to predict premature birth	41
O. Pack	Biomechanics of precision-cut lung slices during biaxial distension	43
P.T. Ph <sup>a</sup> m	Limit and shakedown analysis for bounded kinematic hardening bodies	45
M. Raue	Design and characterisation of intelligent hydrogels	47
S. Reisert	Development of a sensor system for the validation of aseptic processes	49
A. E. Robinson	Development and testing of hydrogen-fuelled combustion chambers for use in an ultra-micro gas turbine	51
M. Rusack	Development of a new concept for using the heat content of sewage to run heat pumps	53
S. Skorupa	XML-based history tracing in an actor-driven grid-enabled workflow system	55
N. E. Thenent	Hydrostatic propeller drive	57
M. Turek	Detection of cyanide by means of silicon-based semiconductor sensors	59
C. F. Werner	Bio-LAPS – optimising of the operation of a biogas fermenter by means of a field-effect biosensor based on a light-addressable potentiometric sensor (LAPS)	61



## Vorwort / Preface

Nach dem gelungenen Start des Aufbaus eines hochschulinternen Netzwerkes der Doktorandinnen und Doktoranden mit der ersten Graduiertentagung im September 2008 möchten wir an diesen Erfolg mit der diesjährigen Veranstaltung anknüpfen. Die Resonanz der Teilnehmer, der externen Referenten und der Zuhörer hat uns gezeigt, wie wichtig eine starke Einbindung der Doktorandinnen und Doktoranden in ein hochschulweites Netzwerk ist und wie befruchtend die Diskussion über die Fachgrenzen hinaus für alle Beteiligten war.

Die Arbeit des Graduiertenseminars hat im vergangenen Jahr an „Fahrt gewonnen“. Unsere Graduierten erfahren in der Hochschule eine zunehmende Wahrnehmung, die sich vor allem auch darin äußert, dass sie ihre Belange in den forschungsrelevanten Gremien der Hochschule vertreten können und erhalten mittlerweile durch Bereitstellung von Rektoratsmitteln auch eine finanzielle Unterstützung.

Noch ist die Zusammenarbeit über die Standortgrenzen hinweg etwas schwierig, aber wir hoffen, dass durch Veranstaltungen wie diese, das Zusammengehörigkeitsgefühl weiter wächst. Die Prorektorin für Forschung, Entwicklung und Technologietransfer sichert ihre volle Unterstützung zu, um das angestrebte Ziel möglichst schnell zu erreichen.

Die diesjährige Graduiertentagung bietet Ihnen wieder die Möglichkeit, Ihre wissenschaftlichen Arbeitsergebnisse einem interessierten Fachpublikum vorzustellen und in den intensiven Dialog mit Ihren Kolleginnen und Kollegen sowie den geladenen Gästen einzutreten. Wir haben in diesem Jahr wiederum zwei bedeutende Gastredner gewinnen können, Prof. Dr. Rainer Fischer (Fraunhofer-Institut für Molekulare und Angewandte Ökologie, Aachen) und Prof. Dr. Andreas Offenhäusser (Institut für Bio- und Nanosysteme am Forschungszentrum Jülich).

Wir freuen uns auf einen interessanten Tag gemeinsam mit Ihnen und sind sicher, dass Sie mit Ihrem Beitrag auch in diesem Jahr wiederum die wissenschaftliche Landschaft der FH Aachen bereichern werden.

September 2009



Prof. Dr. Christiane Vaeßen  
Prorektorin für Forschung,  
Entwicklung und Technologietransfer



Prof. Dr. Michael J. Schöning  
Institut für Nano- und  
Biotechnologien (INB)

## Curriculum Vitae



### Prof. Dr. Andreas Offenhäusser

Geburtsdatum 2. Februar 1959  
Geburtsort Heidenheim/Baden-Württemberg

#### Studium:

1979 – 1985 Studium der Physik und Mathematik an der Universität Ulm

#### Wissenschaftlicher Werdegang:

1986 – 1989 Doktorand an der Abteilung Biophysik, Universität Ulm  
1989 Promotion  
1990 – 1992 Entwicklungsingenieur Robert Bosch GmbH, Reutlingen  
1992 – 1994 Frontier Researcher at Laboratory for Exotic Nano-Materials, Frontier Research Program, RIKEN, Japan and Visiting Scientist Tohoku University, Sendai, Japan  
1994 – 2001 Gruppenleiter am Max-Planck-Institut für Polymerforschung, Mainz  
2001 Habilitation Physikalische Chemie, Universität Tübingen  
seit 2001 Direktor des Institut für Bio- und Nanosystem, Bio- und Chemosensoren (IBN-2), Forschungszentrum Jülich GmbH  
seit 2002 Professor für Experimentalphysik, RWTH Aachen



## Curriculum Vitae



### Prof. Dr. Rainer Fischer

Geburtsdatum: 4. August 1958  
Geburtort: Bargteheide (Kreis Stormarn)

#### Studium:

1981 – 1986 Biologiestudium an der Eberhard-Karls Universität Tübingen  
1986 Diplomarbeit (Institut für Virologie der Eberhard-Karls Universität Tübingen)

#### Wissenschaftlicher Werdegang:

1981 Gesellenprüfung als Milchwirtschaftlicher Laborant (Südmilch AG)  
1981 Laborant bei der Scherer AG, Eberbach  
1984 – 1986 Stipendiat der Studienstiftung des deutschen Volkes  
1987 – 1989 Anfertigung der Dissertation am Institut für Biologie I der RWTH Aachen unter Anleitung von Prof. Dr. F. Kreuzaler  
1989 – 1990 Sechsmonatiger Forschungsaufenthalt bei Dr. J. Shively am „Beckman Research Institute“ der City of Hope in Duarte, Kalifornien, USA  
1990 Promotion am Institut für Biologie I der RWTH Aachen/Uni Tübingen  
1990 – 1991 Post-Doktorand im Labor von Dr. J. Shively am „Beckman Research Institute des City of Hope National Medical Centre“ in Duarte, Kalifornien, USA  
1991 – 1993 Projektleiter bei der „Baxter Healthcare Corporation“ (Immunotherapy Division) in Santa Ana, Kalifornien, USA  
1993 – 1996 Wissenschaftlicher Assistent am Institut für Biologie I der RWTH Aachen  
1996 – 2001 Oberingenieur am Institut für Biologie I der RWTH Aachen  
9 – 1998 Nebentätigkeitsvertrag bei der Fraunhofer Gesellschaft und Abteilungsleiter „Molekulare Biotechnologie“ am IUCT in Schmallenberg/Aachen  
seit 3-2001 C4-Lehrstuhlinhaber „Molekulare Biotechnologie“ an der RWTH Aachen  
seit 3-2001 Direktor des Fraunhofer IUCT in Schmallenberg/Aachen  
seit 10-2001 Senior Executive Direktor des Fraunhofer IME in Schmallenberg/Aachen und am Fh-Center for Molecular Biotechnology (CMB) in Newark, Delaware, USA  
2003 Mitgründer AAvantgarde Laboratories AG (Aachen, Germany)  
2004 Mitgründer PharMedartes GmbH (Bochum, Germany)  
2006 Mitgründer Medusa Biotech (Kuala Lumpur, Malaysia)  
2009 Mitgründer AgroProtect GmbH (Aachen, Germany)

## Curriculum Vitae



Nachname / Name: Abounaga  
Vorname / First Name: El-Hussiny  
Titel / Title: M.Sc.

Hochschule / University: FH Aachen  
Standort / Location: Campus Jülich  
Institut für Nano- und Biotechnologien (INB)

Adresse der Hochschule / Address of the University: Ginsterweg 1, 52428 Jülich  
Telefon (Büro/Labor) / Phone (Office/Laboratory): 0241/6009-53044  
Fax: 0241/6009-53199  
E-Mail: h\_abounaga@anut.fh-aachen.de  
Raumnummer (Büro/Labor) /  
Room Number (Office/Laboratory): H113e  
H 404/H 402  
Fachbereich: Chemie und Biotechnologie

Name des Projektes / Name of the project: Cloning and expression of clostridium  
difficile butyrate synthetic genes in Escherichia coli

Betreuender Professor an der FH Aachen /  
Professor attending to the  
University of Applied Sciences Aachen: Prof. Dr. rer. nat. Thorsten Selmer

Partneruniversität / Partner University: Mansoura University, Egypt  
Philipps-University, Marburg, Germany

Betreuender Professor an der Universität /  
Professor attending to the University: Prof. Dr. Ahmed El-Refai  
Prof. Dr. Wolfgang Buckel

Projektpartner / Project Partner:

## Cloning and expression of clostridium difficile butyrate synthetic genes in Escherichia coli

E. Aboulnaga<sup>\*1,3</sup>, A. El-Refai<sup>3</sup>, W. Buckel<sup>2</sup> and T. Selmer<sup>1</sup>

<sup>1</sup> Institute of Nano- and Biotechnologies (INB), Aachen University of Applied Sciences, 52428 Jülich, Germany

<sup>2</sup> Laboratory for Microbiology, Department of Biology, Philipps-University, 35032 Marburg, Germany

<sup>3</sup> Faculty of Agriculture, Mansoura University, 35516 Mansoura, Egypt

\* h\_aboulnaga@anut.fh-aachen.de

The butyrate biosynthetic pathway in *Clostridium difficile* consists of eight genes (*thiA1*, *hbd*, *crt2*, *bcd\_etfB2\_etfA2*, *ptb* and *buk*) encoding the enzymes for thiolase (EC 2.3.1.9), 3-hydroxybutyryl-CoA dehydrogenase (EC 1.1.1.157), crotonase (EC 4.2.1.17), phosphate butyryltransferase (EC 2.3.1.19), butyrate kinase (EC 2.7.2.7) and the butyryl-CoA dehydrogenase complex composed of crotonyl-CoA reductase (EC 1.3.99.2) and two subunits of an electron transfer flavoprotein. Functional expression of these genes in the gut bacterium *Escherichia coli* enables reduction of acetyl-CoA to butyric acid. Though butyrate production is not by itself commercially interesting, the biosynthetic line established in this work is part of several biosynthetic pathways involved in biotechnological production of commercially interesting solvents (e.g. butan-1-ol or propan-1-ol), dyes or polyketide antibiotics.

In the past, it has been shown that transfer of the ortholog genes from *C. acetobutylicum* into *E. coli* yielded recombinant strains capable of butyrate production [1]. Previous work, however, was hampered by the need to clone and express individual genes on various plasmids, thereby creating recombinant *E. coli* cells, which had to cope with multiple antibiotics in the growth medium.

The aim of our research is the creation of a "butyrate module" for metabolic pathway design, which can be used to transfer the information for butyrate formation coded on a single plasmid into the host. This module might be later combined with auxiliary elements that encode different metabolic pathways, which either rely on butyric acid supply as building block for subsequent syntheses or provide acetyl-CoA from various renewable sources.

In order to achieve the aim of our project, the genes from *C. difficile* were first individually cloned and sequenced into the dedicated entry vector of a combinatorial cloning system recently developed in our group [2,3]. Then, individual proteins and the assembly of the three genes encoding butyryl-CoA dehydrogenase were transferred into dedicated expression vectors and used to produce the particular enzymes for functional testing in *E. coli*. Subsequently, the individual genes will be combined in a single plasmid for regulated expression in an artificial operon for in vivo testing of the full pathway in *E. coli*.

<sup>1</sup> Inui, M. et al., Expression of *Clostridium acetobutylicum* butanol synthetic genes in *Escherichia coli*. *Appl Microbiol Biotechnol* **77**, 1305-1316 (2008).

<sup>2</sup> Pinkenburg, O. Fischer, R. and Selmer, T., Fast fusion cloning with class IIS endonucleases, in preparation.

<sup>3</sup> (2008) WO2008095927 (A1) Acc. No.: WO2008EP51396 20080205: Method Of Cloning At Least One Nucleic Acid Molecule Of Interest Using Type IIs Restriction Endonucleases, And Corresponding Cloning Vectors, Kits And System Using Type IIs Restriction Endonucleases. Patent Assignee: Philipps-University Marburg; Inventors: Selmer, T.; Pinkenburg, O.

## Curriculum Vitae



Nachname / Name: Hadji Abouzar  
Vorname / First Name: Maryam  
Titel / Title: M.Sc.

Hochschule / University: FH Aachen  
Standort / Location: Campus Jülich  
Institut für Nano- und Biotechnologien (INB)

Adresse der Hochschule / Address of the University: Ginsterweg 1, 52428 Jülich  
Telefon (Büro/Labor) / Phone (Office/Laboratory): 0241/6009-53215  
Fax: 0241/6009-53235  
E-Mail: hadji-abouzar@fh-aachen.de  
Raumnummer (Büro/Labor) /  
Room Number (Office/Laboratory): H 311  
Fachbereich: Medizintechnik und Technomathematik

Name des Projektes / Name of the project: Feldeffektbasierte Elektrolyt-Isolator-Halbleitersensoren für die Detektion molekularer Wechselwirkungen

Betreuender Professor an der FH Aachen /  
Professor attending to the  
University of Applied Sciences Aachen: Prof. Dr.-Ing. Michael J. Schöning

Partneruniversität / Partner University: Humboldt-Universität zu Berlin  
Betreuender Professor an der Universität /  
Professor attending to the University: PD Dr. Werner Moritz

Projektpartner / Project Partner: Institut für Bio- und Nanosysteme,  
Forschungszentrum Jülich GmbH  
Institute for Materials Research,  
Hasselt University, Belgium  
Institute of Chemistry,  
The Hebrew University of Jerusalem, Israel

## Detection of adsorption and binding of charged macromolecules by means of semiconductor field-effect devices

M.H. Abouzar<sup>1,2,\*</sup>, A. Poghossian<sup>1,2</sup>, W. Moritz<sup>3</sup>, M.J. Schöning<sup>1,2</sup>

<sup>1</sup> Institute of Nano- and Biotechnologies (INB), Aachen University of Applied Sciences, 52428 Jülich, Germany

<sup>2</sup> Institute of Bio- and Nanosystems (IBN-2), Research Centre Jülich GmbH, 52425 Jülich, Germany

<sup>3</sup> Institute of Chemistry, Humboldt University Berlin, 12489, Berlin, Germany

\* hadji-abouzar@fh-aachen.de

The use of a semiconductor field-effect device (FED) platform for a label-free detection of molecular interactions at solid-liquid interfaces could offer a new approach for the development of genosensors, DNA (deoxyribonucleic acid) arrays and protein chips with a fast and direct electrical readout. However, there are still some open questions regarding the detection mechanism of FEDs functionalised with charged macromolecules [1].

In this work, field-effect-based capacitive EIS (electrolyte-insulator-semiconductor) sensors functionalised with charged macromolecules, like DNA and polyelectrolytes, as well as nanoparticle/recognition molecule hybrids have been developed and investigated (Fig. 1). Beside a simple layout, absence of a complicated encapsulation procedure and thus, easier and cost-effective fabrication with the EIS transducer structure, it is possible to study both the impedance and charge effects induced by the charged macromolecules. Further work will focus on the development of physical models explaining the functioning of these devices.

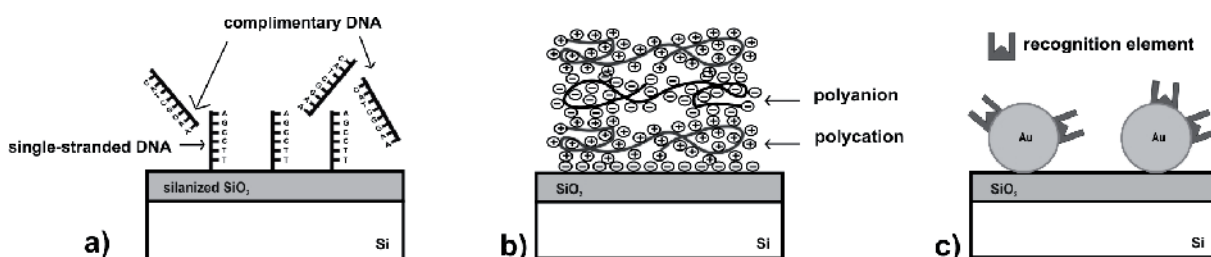

Fig. 1: a) Schematic of the DNA sensor based on a capacitive EIS structure, b) PE multilayer deposited on an EIS structure by layer-by-layer technique and c) EIS structure functionalised with a gold nanoparticle/recognition molecule hybrids system.

[1] M.J. Schöning, M.H. Abouzar, A. Poghossian, Y. Han, A. Offenhäusser, S. Ingebrandt, *Technisches Messen* 9 (2007) 466.

## Curriculum Vitae



Nachname / Name: Bäcker  
Vorname / First Name: Matthias  
Titel / Title: Dipl.-Ing.

Hochschule / University: FH Aachen  
Standort / Location: Campus Jülich  
Institut für Nano- und Biotechnologien (INB)

Adresse der Hochschule / Address of the University: Ginsterweg 1, 52428 Jülich  
Telefon (Büro/Labor) / Phone (Office/Laboratory): 0241/6009-53215  
Fax: 0241/6009-53235  
E-Mail: baecker@fh-aachen.de  
Raumnummer (Büro/Labor) /  
Room Number (Office/Laboratory): H 311  
Fachbereich: Medizintechnik und Technomathematik

Name des Projektes / Name of the project: Modulares Sensorsystem für die  
Zellkultur-Prozessentwicklung „Cellsens“

Betreuender Professor an der FH Aachen /  
Professor attending to the  
University of Applied Sciences Aachen: Prof. Dr.-Ing. Michael J. Schöning

Partneruniversität / Partner University: Universität Hasselt  
Betreuender Professor an der Universität/  
Professor attending to the University: Prof. Dr. Patrick Wagner

Projektpartner / Project Partner: HiTec Zang GmbH  
Philipps-Universität Marburg  
Fraunhoferinstitut für  
Molekularbiologie und Angewandte Ökologie Aachen  
Institut für Bio- und Nanosysteme,  
Forschungszentrum Jülich GmbH

## Modular solid-state sensor system for cell-culture process development

M. Bäcker<sup>1,2\*</sup>, M. Biselli<sup>1</sup>, A. Poghossian<sup>1,2</sup>, W. Zang<sup>3</sup>, P. Wagner<sup>4</sup>, M.J. Schöning<sup>1,2</sup>

<sup>1</sup> Institute of Nano- and Biotechnologies (INB), Aachen University of Applied Sciences, 52428 Jülich, Germany

<sup>2</sup> Institute of Bio- and Nanosystems (IBN-2), Research Centre Jülich GmbH, 52428 Jülich, Germany

<sup>3</sup> HiTec Zang GmbH, 52134 Herzogenrath, Germany

<sup>4</sup> Institute for Materials Research, Hasselt University, Belgium

\* baecker@fh-aachen.de

The aim of the research project is the development of a sensor system for the optimisation of cell-culture fermentation processes with respect to an increased productivity and quality of biopharmaceuticals. Detailed knowledge about the cell's current metabolism and culture parameters in the fermenter is necessary in order to positively influence the process by adding nutrients or pH regulators. Online measurements and controlling of temperature, pH value, and dissolved oxygen is state-of-the-art for industrial applications. However, these measurements are conducted with 'macroscopic' electrodes, which are not useful in small-sized fermenters. Furthermore, the repeated sterilisation of those electrodes makes a frequent change unavoidable. Hence, a fast inline acquisition of the essential culture parameters is fundamental for optimising culture processes.

A multifunctional, modular solid-state sensor system as depicted in Figure 1 is currently developed for the simultaneous inline data acquisition of culture parameters. The system consists of a biosensor module for quantifying the glucose and glutamine concentrations and a chemical sensor module for the measurement of the pH, the temperature and the electrical conductivity in the culture medium. The sensor modules are prepared by means of conventional silicon planar technology. This sensor represents a platform that can be implemented into a commercially available fermenter system. In cooperation with the Cell Culture Laboratory at the Aachen University of Applied Sciences, a new feeding strategy based on the data collected will be developed and compared to current strategies.

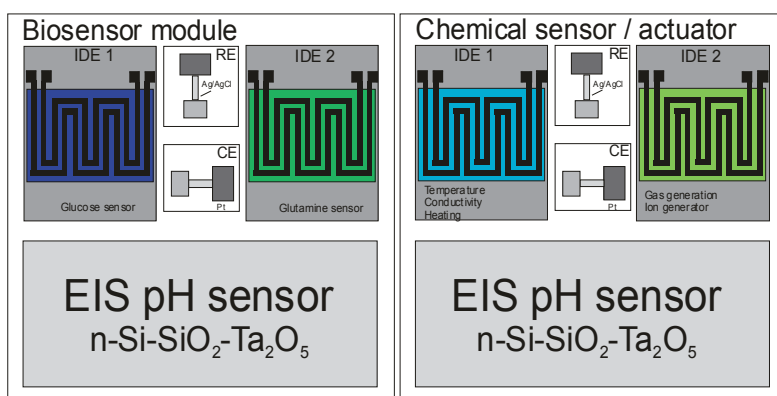

Fig. 1: Layout of the proposed sensor module

## Curriculum Vitae



Nachname / Name: Bassam  
Vorname / First Name: Rasha  
Titel / Title: M.Sc.

Hochschule / University: FH Aachen  
Standort / Location: Campus Jülich

Adresse der Hochschule / Address of the University: Ginsterweg 1, 52428 Jülich  
Telefon (Büro/ Labor) / Phone (Office/Laboratory): 0241/6009-53043  
Fax:  
E-Mail: rashabassamss84@gmail.com  
Raumnummer (Büro/Labor) /  
Room Number (Office/Laboratory): H208-210  
Fachbereich: Biomedical Engineering/  
Kompetenzplattform Bioengineering

Name des Projektes / Name of the project: Effect of nitric oxide on protein thermal stability

Betreuender Professor an der FH Aachen /  
Professor attending to the  
University of Applied Sciences Aachen: Prof. Dr. rer. nat. habil. Gerhard M. Artmann

Partneruniversität / Partner University: Universität zu Köln  
Betreuender Professor an der Universität /  
Professor attending to the University: Prof. Dr. med. J. Hescheler;  
Institut für Neurophysiologie;

Projektpartner / Project Partner:



## Effect of nitric oxide on protein thermal stability

R. Bassam\*<sup>1</sup>, I. E. Digel<sup>1</sup>, G. Artmann<sup>1</sup>

<sup>1</sup> Institute of Bioengineering, Laboratory of Cell Biophysics, Aachen University of Applied Sciences, 52428 Jülich, Germany

\* rashabassamss84@gmail.com

Nitric oxide (NO) is one of the most important signal molecules in living cells. Before it had been considered as an atmospheric pollutant and bacterial metabolite, and recently a huge discover of NO role in physiological process occur, making it the target of many studies. It appears that a simple molecule like NO can play a key bio-regulatory function in a number of physiological processes.

Some of these processes are still unknown, in such a way the interaction of NO in RBC's is vital to clarify the metabolic fate of NO in vascular systems, and this leads to another goal, in which the related effect of NO on hemoglobin (Hb) and other proteins may lead to the explanation of the controversial issues surrounding NO.

Since the unique native structure of most proteins is a basic requirement for proper functioning, the ability to build and keep this native and functional structure needs a particular range of temperature. Therefore, temperature variation was applied on the protein in the presence and absence of NO to study their both effect on protein structural stability and hydration. After that, another parameter was considered, which include the usage of different ions to study their effects on proteins structural stability and hydration.

Specific NO donors were accustomed and various proteins were used in this investigation such as hemoglobin (Hb), Bovine Serum Albumin (BSA) and myoglobin which were prepared either in, Phosphate Buffer Saline (PBS, sodium based), or in Circular Dichroism buffer (CD, potassium based).

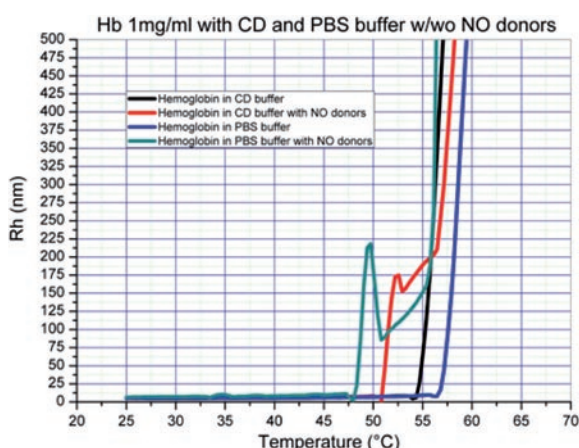

Numerous techniques were employed to characterize the structural and dynamical properties of proteins, such a technique was the Quasielastic Light Scattering (Dynamic Light Scattering). It is an optical method used for the determination of hydrodynamic radius and translational diffusion of protein particles that undergo Brownian motion.

Around 60 experiments were performed using different proteins; some of these results are shown in Fig.1, in which the effect of nitric oxide, different ions and temperature variation was examined. Therefore, as a deduction from these results, we can conclude that proteins mainly in vitro, denature totally at a temperature between 57°C – 62°C, and they also affected by NO and different ions types. In which mainly, NO cause earlier protein denaturation, which means that, NO has a destabilizing effect on proteins, and also different ions will alter the protein denaturation in which, some ions will cause earlier protein denaturation while others not.

## Curriculum Vitae



Nachname / Name: Berretz  
Vorname / First Name: Frank  
Titel / Title: M.Sc.

Hochschule / University: FH Aachen  
Standort/Location: Campus Jülich

Adresse der Hochschule / Address of the University: Ginsterweg 1, 52428 Jülich  
Telefon (Büro/Labor) / Phone (Office/Laboratory): 0241/6009-53277  
Fax:  
E-Mail: berretz@fh-aachen.de  
Raumnummer (Büro/Labor) /  
Room Number (Office/Laboratory): H4  
Fachbereich: Medizintechnik und Technomathematik

Name des Projektes / Name of the project: HiX for AGWS – XML-based history tracing  
in an actor-driven grid-enabled workflow system

Betreuender Professor an der FH Aachen /  
Professor attending to the  
University of Applied Sciences Aachen: Prof. Dr. Volker Sander

Partneruniversität / Partner University: University of Amsterdam  
Betreuender Professor an der Universität /  
Professor attending to the University: Prof. Dr. Adam Belloum

Projektpartner / Project Partner: Dipl.-Math. Mario Klöcker, Waagenbau Dohmen GmbH  
Dr. Achim Streit, Jülich Supercomputing Centre,  
Forschungszentrum Jülich GmbH

## XML-based history tracing in an actor-driven grid-enabled workflow system

S. Skorupa<sup>1,\*</sup>, F. Berretz<sup>1,\*\*</sup>

<sup>1</sup> Aachen University of Applied Sciences, 52428 Jülich, Germany

\*Skorupa@fh-aachen.de, \*\*Berretz@fh-aachen.de

Current e-Science infrastructures provide support for complex scientific processes that consist of orchestrated resources such as pure computational devices, specific applications, data repositories, or scientific instruments. In order to support the orchestration of scientific tasks, Grid middleware platforms like UNICORE offer a workflow management system as an enactment service build on top of the middleware. The most common approach in Grid workflow management systems supports the push-pattern of the known workflow resource patterns. Here, a software agent, e.g. the workflow engine, actively exercises control about the progress of a workflow by pushing the individual tasks to the selected resources according to the dependencies, provided by the workflow description. Various advances to the management system have been performed to assure data or process oriented provenance or to allow for a late binding of tasks to resources. A fundamental barrier remains with respect to the acceptance: The push-model requires that a service receives a particular level of control about the resources. While this barrier is addressed by the foundation of virtual organizations and by the introduction of Service Level Agreements, a pull-based approach could offer new perspectives for e-Science infrastructures. Here, resources can not only actively select which work item they wish to commence next, it also allows the integration of human interaction patterns according to emerging standards such as WS-HumanTask.

The project's idea is to develop a pull-based approach for workflow management in Grid environments. The approach was motivated by a specific provenance concept in a single e-Government application domain that relies on layered, digitally signed XML-documents that traces the history of operations in a legally usable form. It generalizes the idea of using layered, digitally signed XML-documents to trace the progress of a workflow and introduces a pull-based approach to Grid workflow management by an intermediary that mediates between workflow instances and resources.

## Curriculum Vitae



Nachname / Name: Betsch  
Vorname / First Name: Matthias  
Titel / Title: Dipl.-Ing., M.Sc.

Hochschule / University: FH Aachen  
Standort / Location: Campus Jülich,  
NOWUM-Energy

Adresse der Hochschule / Address of the University: Ginsterweg 1, 52428 Jülich  
Telefon (Büro/ Labor) / Phone (Office/Laboratory): 0241/6009-53021  
Fax: 0241/6009-53288  
E-Mail: [betsch@nowum-energy.com](mailto:betsch@nowum-energy.com)  
Raumnummer (Büro/Labor) /  
Room Number (Office/ Laboratory): H 7f  
Fachbereich: Energietechnik

Name des Projektes / Name of the project: Umbau einer  $\mu$ -Turbine zu einer  
extern befeuerten Maschine mit Ankopplung an eine  
Stationäre – Wirbelschichtfeuerung

Betreuender Professor an der FH Aachen /  
Professor attending to the  
University of Applied Sciences Aachen: Prof. Dr. Klaus Dielmann

Partneruniversität / Partner University: Universität Rostock  
Betreuender Professor an der Universität /  
Professor attending to the University: Prof. Dr. Dieter Steinbrecht

Projektpartner / Project Partner: E-quad Power Systems GmbH  
ES+S, Energy Systems & Solutions GmbH

## Decentralised stream production of biomass by coupling of a stationary fluidised bed combustion with an externally fired microgasturbine

M. Betsch\*<sup>1,2</sup>, K. Dielmann<sup>1</sup>, D. Steinbrecht<sup>2</sup>, T. Vincent<sup>2</sup>

<sup>1</sup> Institut NOWUM-Energy, Aachen University of Applied Sciences, 52428 Jülich, Germany

<sup>2</sup> Institut für Energie- und Umwelttechnik an der Universität Rostock e.V., Germany

\* [betsch@nowum-energy.com](mailto:betsch@nowum-energy.com)

A decentralised energy system of small performance in which an electrical power producing (hot air) microgasturbine is introduced. The necessary energy for operating the microgasturbine is gained by a high temperature heat exchanger in which direct firing of biomass is performed in a stationary fluidised bed combustion chamber. A common steam power process is not necessary. The energy system consists of two subsystems which are only coupled by a high temperature heat exchanger.

Such an externally fired microgasturbine system (SWSF and EFGT) was established in cooperation with Aachen FH, NOWUM-Energy, the university of Rostock and industrial partner and is driven in a parallel mains operation.

As a base served a custom-made direct-fired microgasturbine from which the furnace chamber was removed and was substituted with a (external) high temperature heat exchanger. The advantage of the realised principle is that after the carried out modification to the external energy supply by a high temperature heat exchanger is that the hot air flowing through the microgasturbine does not any more get into contact with the combustion exhaust gases. The operating results preserved after the modification are introduced.

The thermo-dynamic conditions of both systems for an optimised power production are discussed.

The overall system has a very good electrical efficiency for the small range of performance. The (clean) exhaust air of the microgasturbine can be used for CHP purposes as well as for drying processes in the industrial sector. The stationary fluidised bed combustion as well as the microgasturbine are tested products in the fully automatic continuous operation. The regulation of the system is done by a performance regulation of stationary fluidised bed combustion. The microgasturbine is regulated by the available heat from the high temperature heat exchanger behind.

As fuels for the energy system dump-weak gases or waste materials (e.g., from the EBS production) are also applicable besides of biomass.

## Curriculum Vitae



Nachname / Name: Börner  
Vorname / First Name: Sebastian  
Titel / Title: Dipl.-Ing., MBA

Hochschule / University: FH Aachen  
Standort / Location: Aachen

Adresse der Hochschule / Address of the University: Hohenstaufenallee 6, 52064 Aachen  
Telefon (Büro) / Phone (Office): 0241/6009-52808  
Fax: 0241/6009-52680  
E-Mail: boerner@fh-aachen.de  
Raumnummer (Büro/Labor) /  
Room Number (Office/ Laboratory): 04109  
Fachbereich: Luft- und Raumfahrttechnik

Name des Projektes / Name of the project: Wasserstoff-Gasturbine

Betreuender Professor an der FH Aachen /  
Professor attending to the  
University of Applied Sciences Aachen: Prof. Dr.-Ing. Harald Funke

Partneruniversität / Partner University: Université Libre de Bruxelles  
Betreuender Professor an der Universität /  
Professor attending to the University: Prof. Dr. Patrick Hendrick

Projektpartner / Project Partner: Royal Military Academy, RMA (Belgien)  
Laser Bearbeitungs- u. Beratungszentrum GmbH  
Diehl Aerospace GmbH  
Honeywell Aerospace GmbH

# Low NO<sub>x</sub> hydrogen fuelled gas turbine

S. Börner<sup>\*1</sup>

<sup>1</sup> Aachen University of Applied Sciences, 52066 Aachen, Germany

\* boerner@fh-aachen.de

## Context

The global warming and the worldwide rising energy demand are one of the major challenges of the next years. In order to solve these problems the world, especially the leading industrial nations, is in search of alternative and renewable energy sources. Hydrogen could be such a solution. In addition hydrogenous gases emerge from the decarbonisation of conventional fuels.

## Outline of the research project:

The target of the research project is to develop a scalable low NO<sub>x</sub> hydrogen fuelled combustion chamber concept, based on the principle of the micro-mix-combustion being used in a conventional gas turbine.

The micro-mix-burning-principle is used as combustion process for the engine's combustion chamber. This principle is based on the jet-in-a-cross-flow-principle. I.e. the hydrogen is injected vertical in the airstream. After mixing by cross flow interaction the hydrogen burns instantly with a diffusive flame. Two identical gas turbines [APU GTCP 36-300] are available for the project. One turbine is modified for the hydrogen application. The other kerosene fuelled is just for the benchmark with the hydrogen. This research project is divided in three major topics and its innovations:

1. A prototype test burner based on the design concept of the future combustion chamber conduces for the deep analysis of the micro-mix-combustion-principle and its influencing parameters for an efficient and low-Nox combustion of the hydrogen.
2. The results of the test burner investigation and the ambition to develop a scalable and economic combustion chamber for an industrial fullscale gas turbine have an impact on the future design and the manufacturing process of the combustion chamber.
3. The hydrogen operated gas turbine and its safety is controlled during operation by the Full Authority Engine Control System (FADEC). For the operation with hydrogen as a fuel a new closed loop control system with the related software applications and modifications that considers the burning characteristics of the combustion chamber is to be developed.

## Curriculum Vitae



Nachname / Name: .  
 Vorname / First Name:  
 Titel / Title:

Dương  
 Minh Tuấn  
 M.Sc., M.Eng.

Hochschule / University:  
 Standort / Location:

FH Aachen  
 Campus Jülich

Adresse der Hochschule / Address of the University: Ginsterweg 1, D 52428 Jülich  
 Telefon (Büro/Labor) / Phone (Office/Laboratory): 0241/6009-53209  
 Fax: 0241/6009-53199  
 E-Mail: duong@fh-aachen.de  
 Raumnummer (Büro/Labor) /  
 Room Number (Office/Laboratory): H201  
 Fachbereich: Medizintechnik und Technomathematik

Name des Projektes / Name of the project:

Modellierung des Schneidens von weichen Geweben  
 für die interaktive VR-basierte medizinische Simulation

Betreuender Professor an der FH Aachen /  
 Professor attending to the  
 University of Applied Sciences Aachen:

Prof. Dr.-Ing. Manfred Staat

Partneruniversität / Partner University:  
 Betreuender Professor an der Universität /  
 Professor attending to the University:

TU Darmstadt  
 Prof. Dr.-Ing. Ch. Tsakmakis

Projektpartner / Project Partner:

MOET (Ministry of Education and Training of Vietnam),  
 HUT (Hanoi University of Technology),  
 RWTH Aachen



# Modellierung des Schneidens von weichen Geweben für die interaktive VR-basierte medizinische Simulation

M. T. Dưong<sup>1,3</sup>, Ch. Tsakmakis<sup>2</sup>, M. Staat<sup>\*1</sup>

<sup>1</sup> Institute of Bioengineering, Aachen University of Applied Sciences, 52428 Jülich, Germany

<sup>2</sup> Darmstadt Univ. of Technology, Dept. of Civil Eng. & Geodesy, Inst. of Continuum Mech.

<sup>3</sup> Hanoi University of Technology (HUT), Faculty of Mechanical Eng., Hanoi, Vietnam

\*m.staat@fh-aachen.de

Die sichere Durchführung der Regionalanästhesie erfordert theoretische Kenntnisse und gute manuelle Fertigkeiten, die Studierende gut in der Sicherheit einer virtuellen Realität (VR) von Simulatoren einüben können. Zu diesem Zweck wurde an der RWTH das System RASim (regional anaesthesia simulator) im gleichnamigen DFG-Projekt entwickelt. Ein computergeneriertes anatomisches Patientenmodell wird dreidimensional dargestellt, räumlich exploriert und durch intuitiv bedienbare Interaktionsgeräte virtuell manipuliert (Grottke et al., 2009). Eine sehr effektive Finite Elemente Analyse mit stark vereinfachter biomechanischer Modellierung wurde in das Open Source Programm SOFA implementiert, wobei Diskontinuitäten an der Nadelschneide mit XFEM (extended FEM) ohne Erzeugung neuer Elemente mitgeführt wurden (Jeřábková, 2007). Im Labor Biomechanik wurden begleitend Schnittkräfte an Injektionsnadeln gemessen (Tanthuwanit, 2006).

Im jetzt begonnenen Projekt sollen realitätsnahe Modelle für weiches Gewebe einschließlich bruchmechanischer Modelle für das Schneiden theoretisch, messtechnisch und numerisch untersucht werden. Zur Lösung der mit sehr großen Verformungen und InkompRESSibilität verbundenen Probleme wird die neue Klasse der geglätteten Finiten Elemente vorgeschlagen. Sie erlauben zugleich einfachere Netze, asymptotisch geringere Rechenzeiten und sind auch mit XFEM kombinierbar.



VR, RASim, RWTH Aachen

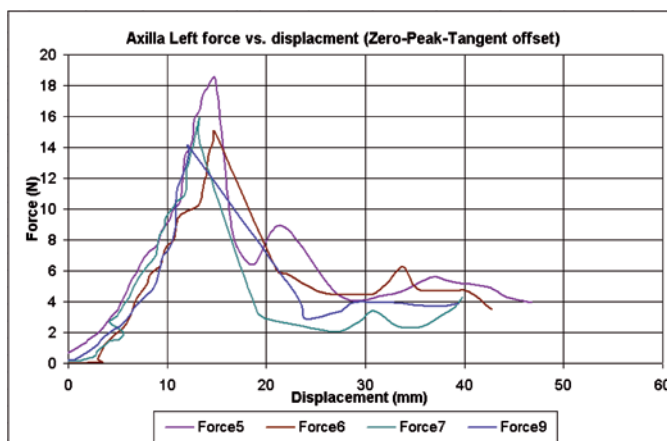

Nadelkräfte, AcUAS

O. Grottke, A. Ntuba, S. Ullrich, W. Liao, E. Fried, A. Prescher, T. M. Deserno, T. Kuhlen, R. Rossaint: Virtual reality-based simulator for training in regional anaesthesia. *Br J Anaesth* (2009) in press <http://dx.doi.org/10.1093/bja/aep224>

L. Jeřábková: *Interactive cutting of finite elements based deformable objects in virtual environments*. Dissertation, RWTH Aachen (2007). <http://darwin.bth.rwth-aachen.de/opus3/volltexte/2007/2094/>

T. Tanthuwanit: *Development of a force and displacement measuring device for anesthesiologist purpose*. Master Thesis, AcUAS Jülich Campus (2006).

## Curriculum Vitae



Nachname / Name: . Groebel  
Vorname / First Name: Simone  
Titel / Title: Dipl.-Ing.

Hochschule / University: FH Aachen  
Standort / Location: Campus Jülich  
Institut für Nano- und Biotechnologien (INB)

Adresse der Hochschule / Address of the University: Ginsterweg 1, 52428 Jülich  
Telefon (Büro/Labor) / Phone (Office/Laboratory): 0241/6009-53232  
Fax: 0241/6009-53288  
E-Mail: groebel@fh-aachen.de  
Raumnummer (Büro/Labor) /  
Room Number (Office/Laboratory): H412/ H413  
Fachbereich: Chemie und Biotechnologie

Name des Projektes / Name of the project: „Bio-LAPS“  
Optimierung des Betriebs eines Biogasfermenters  
mit Hilfe eines Feldeffekt-Biosensors auf der Basis eines  
lichtadressierbaren potentiometrischen Sensors (LAPS)

Betreuender Professor an der FH Aachen /  
Professor attending to the  
University of Applied Sciences Aachen: Prof. Dr. Marcus Baumann

Partneruniversität / Partner University: Universität Rostock  
Betreuender Professor an der Universität /  
Professor attending to the University: Prof. Dr. Berthold Sprenger

Projektpartner / Project Partner:

## Bio-LAPS – optimising of the operation of a biogas fermenter by means of a field-effect biosensor based on a light-addressable potentiometric sensor (LAPS)

S. Groebel<sup>1,2\*</sup>, C. F. Werner<sup>1,3</sup>, H. Spelthahn<sup>1,3</sup>, T. Wagner<sup>1,4</sup>, M. J. Schöning<sup>1,3</sup>, T. Selmer<sup>1</sup>, M. E. M. Baumann<sup>1</sup>

<sup>1</sup> Institute of Nano- und Biotechnologies (INB), Aachen University of Applied Sciences, 52428 Jülich, Germany

<sup>2</sup> Faculty of Mathematica and Natural Science, University of Rostock, 18051 Rostock, Germany

<sup>3</sup> Institute of Bio- and Nano Systems (IBN-2), Research Centre Jülich, 52428 Jülich, Germany

<sup>4</sup> Tohoku University, Department of Electronic Engineering, Japan

\* groebel@fh-aachen.de

The production of biogas (methane) from biomass is a multistep process, which requires contribution of various microbes for biomass degradation and gas production. In the first step, polymers are degraded and converted to complex mixtures of volatile fatty acids (VFAs) by fermenting bacteria. Then, the VFAs are converted to acetate, carbon dioxide and hydrogen by acetogenic bacteria. Finally, the latter compounds are substrates of methanogenic archaea, which form the desired product, methane.

The supply of acetate, carbon dioxide and hydrogen (acetogenesis) is the most critical step in the process. Hence, the information about the onset of this phase is crucial for a stable process in commercially operating plants. Hitherto, suitable sensors providing this information are lacking. The purpose of our study is the development of a novel field-effect biosensor based on a light-addressable potentiometric sensor („Bio-LAPS”) to monitor the metabolic activity and vitality of acetogenic bacteria in cooperation between the laboratory of plant biotechnology and the laboratory of chemical sensors and biosensors.

The aim of the microbiological part of the work is the immobilization of acetogenic bacteria in a homogeneous layer on a chip surface, as shown in figure 1. Acetogenic bacteria fixed on the surface of the chip might be able to sense the accumulation of acetogenic substrates and create a signal due to their metabolic activity. Hence, the identification of microbial species involved in this step by molecular biological methods is an important aspect of the project in order to identify suitable targets for immobilization.

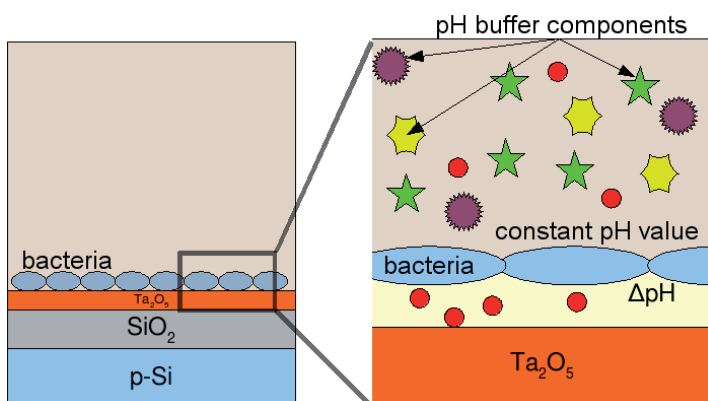

Fig. 1: Principle of organism-mediated signal generation on LAPS

## Curriculum Vitae



Nachname / Name: Heinze  
Vorname / First Name: Daniel  
Titel / Title: Dipl.-Ing.

Hochschule / University: FH Aachen  
Standort / Location: Aachen  
Institut für Angewandte Polymerchemie

Adresse der Hochschule / Address of the University: Worringer Weg 1, 52074 Aachen  
Telefon (Büro/Labor) / Phone (Office/Laboratory): 0241/80-26559  
Fax: 0241/80-22178  
E-Mail: heinze@dwi.rwth-aachen.de  
Raumnummer (Büro/Labor) /  
Room Number (Office/Laboratory): 38B 002  
Fachbereich: Chemie und Biotechnologie

Name des Projektes / Name of the project: Synthesis of exfoliated polyvinyl acetate-layered silicate nanocomposites and their characterisation with respect to the barrier properties

Betreuender Professor an der FH Aachen /  
Professor attending to the  
University of Applied Sciences Aachen: Prof. Dr. Thomas Mang

Partneruniversität / Partner University: RWTH  
Betreuender Professor an der Universität /  
Professor attending to the University: Prof. Dr. Martin Möller

Projektpartner / Project Partner:

# Synthesis of exfoliated polyvinyl acetate-layered silicate nanocomposites and their characterisation with respect to the barrier properties

D. Heinze\*, T. Mang<sup>1</sup>, M. Möller<sup>2</sup>, O. Weichold<sup>2</sup>

<sup>1</sup> Instiut für Angewandte Polymerchemie (IAP), Aachen University of Applied Sciences, 52074 Aachen, Germany

<sup>2</sup> Deutsches Wollforschungsinstitut (DWI), RWTH Aachen, Germany

\* heinze@dwi.rwth-aachen.de

The field of nanotechnology is one of the most popular areas for research and development in a lot of technical and chemical branches. Especially, polymer matrix based nanocomposites have generated a great interest, because they offer significant improvements in material properties. In the nanocomposites, inorganic particles are dispersed at nanoscale level in an organic polymer matrix. If the particles are silicate layers, the composites are called polymer-layered silicate nanocomposites. These silicate layers are used as nanofillers obtaining properties that cannot be maintained with macro- or microscopic inorganic fillers. They belong to the family of phyllosilicates such as montmorillonite and their galleries are occupied by hydrated and alkaline-earth metal cations. The cations can be replaced with organic cations, e.g. alkylammonium ions, forming so called organically modified layered silicates in order to improve the compatibility between polymer and inorganic phase and to increase the distance between the layers. In an exfoliated composite the polymer chains intercalate in the galleries and delaminate the layers, so that the particles are dispersed homogeneously in the polymer matrix. Achieving a good dispersibility and great properties in the composites resulted the inorganic filler have to assume a lot of interactions with the polymer matrix.

The goal of the dissertation is to design exfoliated polyvinyl acetate layered silicate nanocomposites which represent a decreased gas permeability, transparent appearance and high filling degree of the layers. For this purpose, vinyl acetate get mixed with organically modified layered silicate as well as low-molecular polyvinyl acetate, latter should facilitate the exfoliation of the layers, in different disperser (e.g. ultra-sonication) and polymerised obtaining an polymer foil with exfoliated silicate layers. The characterisation will realise in respect of the morphology (i.e. exfoliation), particle size, filling degree and gas permeability. The demonstration of the correlation between concentration of the layered silicate and barrier properties is planned.

## Curriculum Vitae



Nachname / Name: Kirchner  
Vorname / First Name: Patrick  
Titel / Title: Dipl.-Ing.

Hochschule / University: FH Aachen  
Standort / Location: Campus Jülich  
Institut für Nano- und Biotechnologien (INB)

Adresse der Hochschule / Address of the University: Ginsterweg 1, 52428 Jülich  
Telefon (Büro/Labor) / Phone (Office/Laboratory): 0241/6009-53239  
Fax: 0241/6009-53235  
E-Mail: kirchner@fh-aachen.de  
Raumnummer (Büro/Labor) /  
Room Number (Office/Laboratory): I 105  
Fachbereich: Medizintechnik und Technomathematik

Name des Projektes / Name of the project: RFID-basiertes Sensorsystem zur  
Realisierung intelligenter Verpackungen, „Intellipack“

Betreuender Professor an der FH Aachen /  
Professor attending to the  
University of Applied Sciences Aachen: Prof. Dr.-Ing. Michael J. Schöning

Partneruniversität / Partner University: Philipps-Universität Marburg  
Betreuender Professor an der Universität /  
Professor attending to the University: Prof. Dr. Michael Keusgen

Projektpartner / Project Partner: von Hoerner & Sulger GmbH  
Elopak GmbH  
Aspetiksysteme & Foodtechnologie  
Institut für Bio- und Nanosysteme,  
Forschungszentrum Jülich GmbH

## Calorimetric sensor system based on RFID for H<sub>2</sub>O<sub>2</sub> monitoring in aseptic filling processes

P. Kirchner<sup>1,2\*</sup>, H. Henkel<sup>3</sup>, A. Schneider<sup>3</sup>, P. Friedrich<sup>4</sup>, M. Keusgen<sup>5</sup>, M.J. Schöning<sup>1,2</sup>

<sup>1</sup> Institute of Nano- and Biotechnologies (INB), Aachen University of Applied Sciences, 52428 Jülich, Germany

<sup>2</sup> Institute of Bio- and Nanosystems (IBN-2), Research Centre Jülich GmbH, 52425 Jülich, Germany

<sup>3</sup> von Hoerner & Sulger GmbH, 68723 Schwetzingen, Germany

<sup>4</sup> Aseptiksysteme & Foodtechnologie, Germany

<sup>5</sup> Institute of Pharmaceutical Chemistry, Marburg University, 35032 Marburg, Germany

\* kirchner@fh-aachen.de

In aseptic filling processes hydrogen peroxide vapour (HPV) is commonly applied for the microbial reduction of carton packages for food, beverages as well as pharmaceuticals. The prevalent application of HPV in these processes compared to other chemical methods relies on the decomposition of hydrogen peroxide in environmentally compliant reactants, namely water and oxygen. In this case, an aqueous H<sub>2</sub>O<sub>2</sub> solution is evaporated at an elevated temperature and afterwards streamed into a pre-heated package with a constant gas flow. The H<sub>2</sub>O<sub>2</sub> concentration, aggregating up to 10 vol.-% in the gas mixture, correlates thereby with the germicidal effectivity of the microbial reduction process. This correlation points out the requirement of a sensor system for the in-line detection of H<sub>2</sub>O<sub>2</sub> concentrations during the microbial reduction of carton packages.

In this work, a calorimetric sensor system based on RFID (radio frequency identification) is envisaged, which can be embedded into a carton package for the in-line monitoring of the H<sub>2</sub>O<sub>2</sub> concentration during the microbial reduction process (Fig. 1). Therefore, a calorimetric differential set-up on chip level, consisting of a catalytically activated and a passivated temperature sensing element, has been fabricated. As temperature sensing elements for the detection of the reaction heat caused by the exothermal decomposition of H<sub>2</sub>O<sub>2</sub> on a catalyst, thin-film resistances and thermopiles are deposited on a silicon chip. To read out the sensor signal, a passive RFID transponder also on chip level with integrated low-power circuit and energy buffer will be coupled to the calorimetric differential set-up and embedded in a carton package. This "intelligent package" affords the in-line detection of the H<sub>2</sub>O<sub>2</sub> concentration during the aseptic filling process.

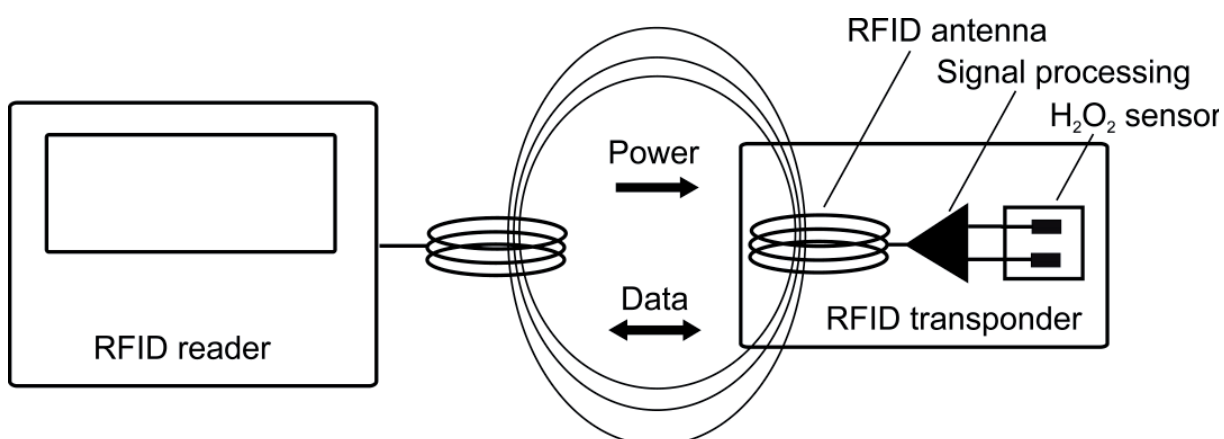

Fig. 1: Scheme of the sensor system based on RFID containing an RFID reader and transponder with antenna, signal processing and H<sub>2</sub>O<sub>2</sub> sensor.

## Curriculum Vitae



Nachname / Name: Kowollik  
Vorname / First Name: Silvia  
Titel / Title: Dipl.-Ing.

Hochschule / University: FH Aachen  
Standort / Location: Campus Jülich  
Institut für Nano- und Biotechnologien (INB)

Adresse der Hochschule / Address of the University: Ginterweg 1, 52428 Jülich  
Telefon (Büro/Labor) / Phone (Office/Laboratory): 0241/6009-53141  
Fax: 0241/6009-53296  
E-Mail: kowollik@fh-aachen.de  
Raumnummer (Büro/Labor) /  
Room Number (Office/Laboratory): H502/ H401  
Fachbereich: Chemie und Biotechnologie

Name des Projektes / Name of the project: Die Rolle des Respirationsquotienten  
in der Zellkulturfermentation

Betreuender Professor an der FH Aachen /  
Professor attending to the  
University of Applied Sciences Aachen: Prof. Dr. Manfred Biselli

Partneruniversität / Partner University: RWTH Aachen  
Betreuender Professor an der Universität /  
Professor attending to the University: Prof. Dr. Rainer Fischer

Projektpartner / Project Partner: Hitec Zang GmbH  
Fraunhofer Institut für  
Molekularbiologie und Angewandte Ökologie  
Aachen



## Relevance of the respiratory quotient in mammalian cell culture fermentation

S. Kowollik\*<sup>1</sup>, R. Krueger<sup>2</sup>, Th. Schnitzler<sup>1</sup>, R. Fischer<sup>3</sup>, W. Zang<sup>2</sup>, M. Biselli<sup>1</sup>

<sup>1</sup> Institute of Nano- and Biotechnologies (INB), Aachen University of Applied Sciences, 52428 Jülich, Germany

<sup>2</sup> Hitec Zang GmbH, 52143 Herzogenrath, Germany

<sup>3</sup> Fraunhofer Institute for Molecular Biology and Applied Ecology, 52074 Aachen, Germany

\* Kowollik@fh-aachen.de

In the last few years recombinant proteins called biopharmaceuticals have become more and more important. Recombinant proteins are medical substances like EPO (Erythropoietin, Roche) or Factor VIII (Bayer Healthcare) that are used for therapeutic and diagnostic purposes. The production of these recombinant proteins takes place in cell culture fermentations because only human or animal cells are able to synthesize these complex substances with complicate structures.

To get high production yields with high quantity and accurate quality, which is relevant for the pharmaceutical function, the monitoring of the fermentation is very important. Normally, industrial processes are controlled by measuring the oxygen uptake rates and measurements of substrats, products and viable cell density. But for this determinations, an interference into the running cultivation is necessary.

Now, a new parameter gives the possibility to observe the fermentation without an intervention into the sterile area. This parameter is called respiratory quotient (Division of carbon dioxid evolution rate (CER) and oxygen uptake rate (OTR)). Up to now, the RQ was not a parameter of interest in cell culture. Because of NaHCO<sub>3</sub>, which is part of the used media, the detection of the CER is very difficult. This is due to the chemical CO<sub>2</sub>, that gets into the headspace of the fermenter, when the cells are producing for example, lactic acid [Bonarius et al., 1995; Frahm et al., 2002].

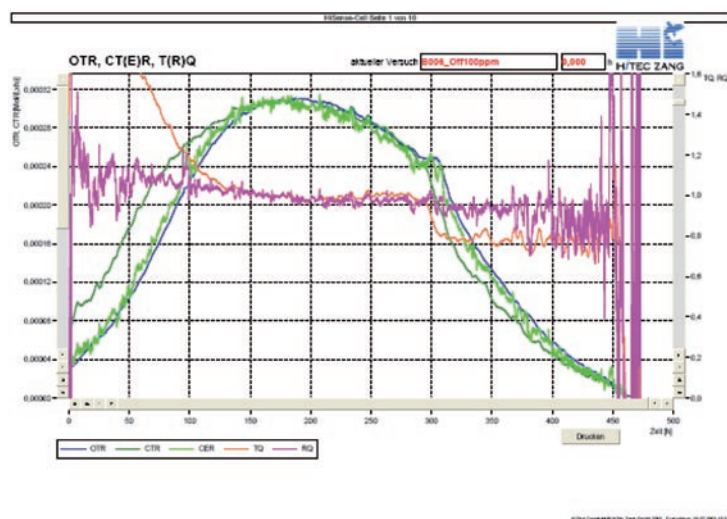

Fig. 1: Measurement of the RQ in cho cells

In hybridoma cells the RQ was already measured with very interesting results in the last year (M. Canzoneri). Now, the RQ is succesfully determined in CHO cells (Abb. 1). This measurement was realized with the analyzer HiSense, which was developed in cooperation with Hitec Zang GmbH, Herzogenrath.

OTR and CER are exactly determined and show indirect the growth of the cells. The quotient of these two (RQ) represent the current metabolism and the state of the cells.

## Curriculum Vitae



Nachname / Name: Kurulgan Demirci  
Vorname / First Name: Eylem  
Titel / Title: M.Sc.

Hochschule / University: FH Aachen  
Standort / Location: Campus Jülich

Adresse der Hochschule / Adress of the University: Ginsterweg 1, 52428 Jülich  
Telefon (Büro/ Labor) / Phone (Office/Laboratory): 0241/6009-53244  
Fax: 0241/6009-53273  
E-Mail:  
Raumnummer (Büro/Labor) /  
Room Number (Office/Laboratory): H208/ H210  
Fachbereich: Medizintechnik und Technomathematik

Name des Projektes / Name of the project: An LPS Based In-vitro Sepsis Model:  
Contractile Tension of Endothelial Cells and Cardiac  
Myocytes – The Potential of a New Therapeutic Concept  
Using RhAPC

Betreuender Professor an der FH Aachen /  
Professor attending to the  
University of Applied Sciences Aachen: Prof. Dr. Dr. (TR). Aysegül Temiz Artmann

Partneruniversität / Partner University: RWTH Aachen  
Betreuender Professor an der Universität /  
Professor attending to the University: Prof. Dr. rer. nat. Jörg Mey

Projektpartner / Project Partner: Firma: Eli Lilly and Company  
Universität: Dokuz Eylül Universität Medizinische Schule,  
Izmir, Türkei

## **Contractile tension of endothelial cells and beating cardiomyocytes: an LPS based in-vitro sepsis model**

E. Kurulgan Demirci\*<sup>1</sup>, P. Linder<sup>1</sup>, T. Demirci<sup>2</sup>, J. Trzewik<sup>1</sup>, I. Digel<sup>1</sup>, P. Kayser<sup>1</sup>,  
D. Porst<sup>1</sup>, M. Gossmann<sup>1</sup>, G. M. Artmann<sup>1</sup>, A. Temiz Artmann<sup>1</sup>

<sup>1</sup> Institute of Bioengineering, Aachen University of Applied Sciences, 52428 Jülich, Germany

<sup>2</sup> Dokuz Eylul University, School of Medicine, Department of Medical Biology and Genetics, Turkey

\* eylemkurulgan@gmail.com

Cellular force is the mechanical tension generated by the cells and is crucial for controlling the cell shape and function (e.g. endothelial cell barrier). In this study, the CellDrum technology developed in our laboratory was used to measure the endothelial cells (HAoEC) and beating cardiomyocytes tension in a lipopolysaccharide (LPS) based in-vitro sepsis model. Quantitative data of forces generated by HAoEC and beating cardiomyocytes under the influence of LPS (a gram – bacteria endotoxin) were shown. Sepsis being the most common cause of shock is the systemic inflammatory response to the infection. During gram – sepsis, the LPS effect on endothelial cells is contraction and on cardiomyocytes it is depression leading to an endothelium permeability increase and cardiac depression respectively. Gram – septic shock comprises 50% of the total case number in sepsis and causes a loss of the endothelial barrier function which are one of the hallmarks of sepsis. In this study, interleukin 6 (IL-6) secretion analysis and TNF  $\alpha$  were used to investigate LPS based in-vitro models. Cellular tension results were obtained with the CellDrum technology. Time course and dose response LPS effects of the cellular tension were added to the study. Thrombin effect on endothelial cell was used as a positive control to verify the cell force data. The LPS activity on the endothelium is known but not really on cardiac tissue. It is the first time this was shown by our CellDrum new technology. This technology will be the only future high-throughput system to observe pathological cellular tension responses of cells in diseases. It is also planned to use this technology for the drug screening tests as well.

## Curriculum Vitae



Nachname / Name: Lawrenz  
Vorname / First Name: Nicole  
Titel / Title: Dipl.-Ing.

Hochschule / University: FH Aachen  
Standort / Location: Campus Jülich,  
Medizinische und Molekulare Biologie,  
Institut für Bioengineering (IfB)

Adresse der Hochschule / Address of the University: Ginsterweg 1, 52428 Jülich  
Telefon (Büro/Labor) / Phone (Office/Laboratory): 0241/6009-53244  
Fax: 0241/6009-53273  
E-Mail: lawrenz@fh-aachen.de  
Raumnummer (Büro/Labor) /  
Room Number (Office/ Laboratory): H208/ H210  
Fachbereich: Medizintechnik und Technomathematik

Name des Projektes / Name of the project: Biomarker zur Prognose von Frühgeburten –  
ein biomedizinischer Ansatz

Betreuender Professor an der FH Aachen /  
Professor attending to the  
University of Applied Sciences Aachen: Prof. Dr. Dr. (TR) Aysegül Temiz Artmann

Partneruniversität / Partner University: Universität zu Köln,  
Klinik und Poliklinik für Frauenheilkunde und Geburtshilfe  
Betreuender Professor an der Universität /  
Professor attending to the University: Univ.-Prof. Dr. med. Peter Mallmann  
(Dr. med. Markus Valter)

Projektpartner / Project Partner: Dokuz Eylül University Medical School, Izmir-Turkey  
(Epidemiologic Studies)

## Biomarker for prognosis of premature birth – a biomedical approach –

N. Lawrenz\*<sup>1</sup>, P. Mallmann<sup>2</sup>, M. Valter<sup>2</sup>, G. M. Artmann<sup>1</sup>, A. Temiz Artmann<sup>1</sup>

<sup>1</sup> Institute of Bioengineering, Aachen University of Applied Sciences, 52428 Jülich, Germany

<sup>2</sup> Clinic for Gynaecology, University of Cologne, Germany

\* lawrenz@fh-aachen.de

Premature rupture of membranes (PROM) is the most frequently cause of premature labor and responsible for 30 - 40% of all premature births. Therefore it is the main clinical and economical problem of obstetrics in our today's world. With a reliable prediction for (P)PROM (preterm PROM: before achievement of the 37<sup>th</sup> week of gestation) and thus for a preterm birth it would be possible to apply suitable therapeutic methods for its prevention. Preterm deliveries and thus neonatal mortality would be reduced enormously. The etiology of PROM, PPROM and also preterm birth are not clarified completely, so that a prediction for (P)PROM and a premature birth are not achievable by measuring only one parameter. Hence, an innovative measuring shall be developed, which is able to predict the risk of a preterm birth already in an early stage of pregnancy by determining a combined selection of biomarkers. Therefore it is important to accomplish the following measurements with the same probands to be able to correlate the results directly.

- Because of the correlation between the collagen content (main component of fetal membranes) of the tissue and PROM, it is important to examine and correlate the bursting pressure and collagen content of human amniotic sac tissue.
- Scientist agree, that there are genetic predispositions which are responsible for preterm labor and preterm births. For this reason dispositions of pregnant women shall be tested for those factors.
- Blood components, which exceeds a hemogram, of pregnant women with and without (P)PROMs shall be examined as well as urine

The aim of the project is to collect enough epidemiological data from the patients which will direct us to new biomarkers for the premature birth early diagnosis and predictions.

## Curriculum Vitae



Nachname / Name: Linder  
Vorname / First Name: Peter  
Titel / Title: Dipl.-Ing., M.Sc.

Hochschule / University: FH Aachen  
Standort / Location: Campus Jülich

Adresse der Hochschule / Address of the University: Ginsterweg 1, 52428 Jülich  
Telefon (Büro/Labor) / Phone (Office/Laboratory): 0241/6009-53244  
Fax: 0241/6009-53273  
E-Mail: linder@fh-aachen.de  
Raumnummer (Büro/Labor) /  
Room Number (Office/ Laboratory): H208/ H210  
Fachbereich: Medizintechnik und Technomathematik

Name des Projektes / Name of the project: HPBioforce

Betreuender Professor an der FH Aachen /  
Professor attending to the  
University of Applied Sciences Aachen: Prof. Dr. rer. nat. habil. Gerhard Artmann

Partneruniversität / Partner University: University College London  
Betreuender Professor an der Universität /  
Professor attending to the University: Prof. Dr. Robert Brown

Projektpartner / Project Partner: BBZ Leipzig  
IKFE Mainz  
IKFE Berlin  
HiTec Zang  
Dr. Gerhard Schmidt GmbH

## HP bioforce

P. Linder\*<sup>1</sup>, C. Preiß<sup>1</sup>, M. Gossmann<sup>1</sup>, G. M. Artmann<sup>1</sup>

<sup>1</sup> Institute of Bioengineering, Aachen University of Applied Sciences, 52428 Jülich, Germany

\* linder@fh-aachen.de

To find and characterize new molecules in drug development for pharmaceutical industry it is a necessary tool to perform functional measurements on isolated cells or thin 3D tissue equivalents, respectively. For cardiovascular systems contractility measurements of cardiomyocytes and vascular muscle cells play an important role. But how can such forces be examined in extremely thin cell layers or shown to be improved by drugs?

The answer is given by the project HPBioforce:

With 1.5 mio Euro in total Prof. Artmann's project HPBioforce (InnoNet) is actually the biggest one in the Center of Competence Bioengineering. The aim is to develop a device which measures the forces produced by cell layers of only few  $\mu\text{m}$  thickness in a fully automated and high throughput system. Active parts will be completely integrated into an incubator so that the cells stay in defined environmental conditions from the seeding, through the culturing till the final examination. The force measurement is based on the CellDrum™ technology, which was developed in the laboratory of Prof. Artmann (figure 1). This system enables us to get data about mechanical tensions in cell and tissue layers which have the magnitude of the surface tension of water in a reproducible and biomechanical defined way.

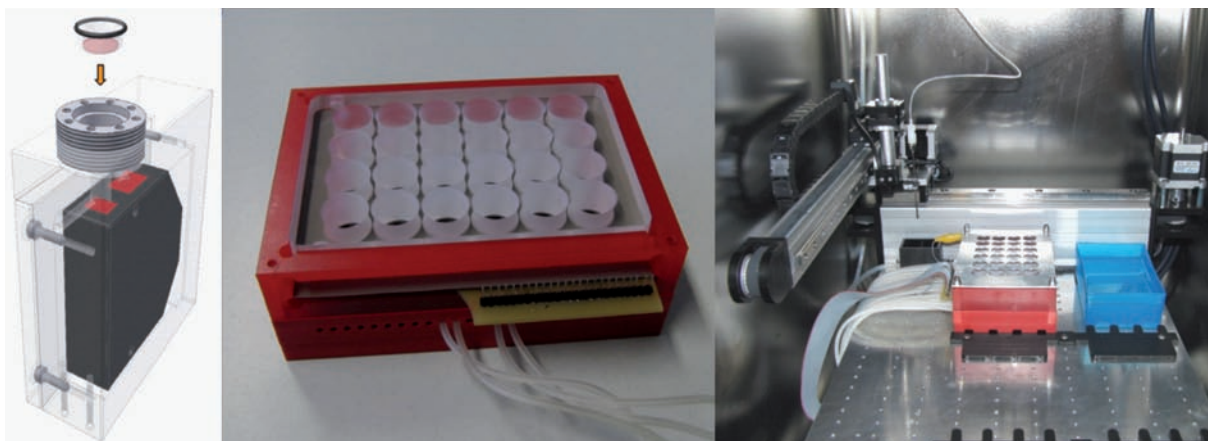

Fig. 1: Tissue Tension Analyzer (left), prototype which was used for preliminary studies. The CellDrum™ (upper part of the picture) is stimulated by an impulse and starts oscillating. The High Throughput measurement station with a 24-well cartridge (center) is based on a similar measurement principle which enables us to perform quasi-static experiments. It is integrated together with a pipetting system into an incubator (right) to avoid disturbances caused by temperature change etc.

## Curriculum Vitae



Nachname / Name: Oflaz  
Vorname / First Name: Hakan  
Titel / Title: M.Sc.

Hochschule / University: FH Aachen  
Standort / Location: Campus Jülich

Adresse der Hochschule / Address of the University: Ginsterweg 1, 52428 Jülich  
Telefon (Büro/Labor) / Phone (Office/Laboratory): 02461/3013292  
Fax: 0241/6009-53273  
E-Mail: hakanoflaz@gmail.com  
Raumnummer (Büro/Labor) /  
Room Number (Office/Laboratory): H208/H210  
Fachbereich: Medizintechnik und Technomathematik

Name des Projektes / Name of the project: Mechanics and structure of amniotic sac tissue potential information to predict premature birth

Betreuender Professor an der FH Aachen /  
Professor attending to the  
University of Applied Sciences Aachen:

Partneruniversität / Partner University: Universität zu Köln,  
Klinik und Poliklinik für Frauenheilkunde und Geburtshilfe  
Betreuender Professor an der Universität /  
Professor attending to the University: Univ.-Prof. Dr. med. P. Mallmann  
(Dr. med. M. Valter)

Projektpartner / Project Partner: Uniklinikum Köln



## **Mechanics and structure of amniotic sac tissue as potential information to predict premature birth**

H. Oflaz<sup>\*1</sup>, P. Linder<sup>1</sup>, M. Valter<sup>2</sup>, E. Wiemer<sup>1</sup>, G. M. Artmann<sup>1</sup>, A. Temiz Artmann<sup>1</sup>

<sup>1</sup> Institute of Bioengineering, Aachen University of Applied Sciences, 52428 Jülich, Germany

<sup>2</sup> Clinic for Gynaecology, University of Cologne, Germany

\* oflaz@fh-aachen.de

Premature birth is one of the main problems of modern obstetrics, which affects 6 % of the annual deliveries in Germany, causing parental suffering, increased perinatal morbidity, mortality of newborn children and extended costs for the German health care system. Biophysicists at the University of Applied Science Aachen and gynecologists at the University Hospital of Cologne developed new investigation methods and instruments to understand the structural integrity of the amniotic sac in order to predict premature birth in the future.

In an extensive in-vitro-study carried out by both universities, amniotic sac tissue samples of 60 deliveries were collected and investigated with the "advanced device to investigate the mechanical properties of amniotic sac tissue" (DIMPAST). Histological investigation after cryopreparation was used to characterize the individual layers of the amniotic sac tissue and their structure. A comparative histological biopsy based on optohistological imaging with a 930 nm spectral radar OCT (Optical coherence tomography) imaging system was carried out to establish optical biopsies of amniotic sac tissue.

DIMPAST is capable of measuring thickness, bursting pressure and the Young's module of amniotic sac tissue providing biomechanical data for any type of soft tissue membranes. Using Spectral radar OCT, we were able to differentiate and analyse intermediate layers of the fetal membranes, the amnion and the chorion.

Correlating the biomechanical data derived with optohistological imaging of fetal membranes and integrating it into a new diagnostic instrument called PROMPT (Premature Rupture Of Membranes Prediction Test) will provide a revolutionary step in obstetrics to safeguard the structural integrity of the amniotic sac by optical biopsy and mechanical testing.

## Curriculum Vitae



Nachname / Name: Pack  
Vorname / First Name: Oliver  
Titel / Title: Dipl.-Ing.

Hochschule / University: Universitätsklinikum Aachen  
Standort / Location: Aachen

Adresse der Hochschule / Address of the University: Institut für Pharmakologie und Toxikologie,  
Wendlingweg 2, 52074 Aachen

Telefon (Büro/ Labor) / Phone (Office/Laboratory): 0241/80-80561  
Fax: 0241/80-82433  
E-Mail: opack@ukaachen.de

Raumnummer (Büro/Labor) /  
Room Number (Office/Laboratory): 235  
Fachbereich: Pharmakologie und Toxikologie

Name des Projektes / Name of the project: Biomechanik von Präzisions-Lungenschnitten  
während einer biaxialen Dehnung (vorläufig)

Betreuender Professor an der FH Aachen /  
Professor attending to the  
University of Applied Sciences Aachen: Prof. Dr. rer. nat. habil. Gerhard M. Artmann

Partneruniversität / Partner University: Medizinische Fakultät der RWTH Aachen  
Betreuender Professor an der Universität/  
Professor attending to the University: Univ.-Prof. Dr. rer. nat. Stefan Uhlig

Projektpartner / Project Partner: Institute for Computational Mechanics,  
Technische Universität, München  
Division of Experimental Anaesthesiology,  
University Medical, Center Freiburg  
Institute of Biochemistry,  
Medical Faculty, RWTH Aachen, University

## Biomechanics of precision-cut lung slices during biaxial distension

O. Pack\*<sup>1,5</sup>, S. Uhlig<sup>1</sup>, G. Artmann<sup>5</sup>, C. Martin<sup>1</sup>, J. Guttman<sup>3</sup>, W.A. Wall<sup>2</sup>,  
C. Dassow<sup>1</sup>, S. Schumann<sup>3</sup>, L. Wiechert<sup>2</sup>, G. Müller-Newen<sup>4</sup>

<sup>1</sup> Institute of Pharmacology and Toxicology, Medical Faculty, RWTH Aachen University, 52074 Aachen, Germany

<sup>2</sup> Institute for Computational Mechanics, Technische Universität München, 85747 Garching, Germany

<sup>3</sup> Division of Experimental Anaesthesiology, University Medical Center Freiburg, 79106 Freiburg, Germany

<sup>4</sup> Institute of Biochemistry, Medical Faculty, RWTH Aachen University, 52074 Aachen, Germany

<sup>5</sup> Labor für Zellbiophysik, Aachen University of Applied Sciences, 52428 Jülich, Germany

\* Opack@ukaachen.de

The mechanical forces acting on lung parenchyma during (mechanical) ventilation and its (patho)physiological consequences are currently under intense scrutiny. Several *in vivo* and cell culture models have been developed to study the pulmonary responses to mechanical stretch. While providing extremely useful information, these models do also suffer from limitations in being either too complex for detailed mechanical or mechanistic studies, or being devoid of the full complexity present *in vivo* (e.g. different cell types and interstitial matrix). Therefore in the present study it was our aim to develop a new model, based on the biaxial stretching of precision-cut lung slices (PCLS). Single PCLS were mounted on a thin and flexible carrier membrane of polydimethylsiloxan (PDMS) in a bioreactor and the membrane was stretched by applying varying pressures under static conditions. Distension of the membrane supporting the PCLS was modelled via finite element simulation. According to this analysis, lung tissue was stretched by up to 38% in the latitudinal and by up to 44% in the longitudinal direction resulting in alveolar distension similar to what has been described in intact lungs. Lung slices were stretched dynamically with a frequency of 15 Hz for 4h, without causing cell injury (MTT test, propidium iodide staining). These findings suggest that stretching of PCLS on PDMS-membranes may represent a useful model to investigate lung stretch in intact lung tissue *in vitro* for several hours. My preliminary scope of duty contains the providing of 3D-rendered lung slice models via analyzed data from a multiphoton-microscope, the development of several aspects of the examination methods, e.g. designing a new bioreactor for analyzing the slices, development of a more precise and simple measurement of the membrane-stretching, a modified procedure for dynamically stretching the membranes and a improved slicing-method.

## Curriculum Vitae



Nachname / Name: Phu Tinh  
Vorname / First Name: PHAM  
Titel / Title: M.Eng.

Hochschule / University: FH Aachen  
Standort/ Location: Campus Jülich

Adresse der Hochschule / Adress of the University: Ginsterweg 1, 52428 Jülich  
Telefon (Büro/Labor) / Phone (Office/Laboratory): 0241/6009-53209  
Fax: 0241/6009-53199  
E-Mail: pham@fh-aachen.de  
Raumnummer (Büro/Labor) /  
Room Number (Office/ Laboratory): H201  
Fachbereich: Medizintechnik und Technomathematik

Name des Projektes / Name of the project: Limit and shakedown analysis  
for bounded kinematic hardening bodies

Betreuender Professor an der FH Aachen /  
Professor attending to the  
University of Applied Sciences Aachen: Prof. Dr.-Ing. Manfred Staat

Partneruniversität / Partner University: TU Darmstadt  
Betreuender Professor an der Universität /  
Professor attending to the University: Prof. Dr.-Ing. Ch. Tsakmakis

Projektpartner / Project Partner: MOET (Ministry of Education and Training of Vietnam)

# Limit and shakedown analysis for bounded kinematic hardening bodies

P.T. Pham<sup>1,3</sup>, Ch. Tsakmakis<sup>2</sup>, M. Staat<sup>1</sup>

<sup>1</sup> Aachen University of Applied Sciences, 52428 Jülich, Germany

<sup>2</sup> TU Darmstadt (TUD)

<sup>3</sup> Hanoi Architectural University (HAU)

pham@fh-aachen.de, m.staat@fh-aachen.de

The thesis develops numerical methods for the calculation of structural limit states to extend the safe operation of structures into the plastic range. The examples in the thesis will demonstrate that the operations limits can be considerably greater than expected from an elastic analysis. The apparatus engineering cannot do without this direct plasticity method. But today there is no commercial Finite Element Code that offers this novel kind of engineering analysis. Basically, in my Ph.D. thesis, I develop a modern primal-dual Optimization Method which solves the problem:

$$\text{maximum safe load} \leq \text{true load capacity} \leq \text{minimum over load.}$$

The upper bound and lower bound solution are found simultaneously (Fig.1)

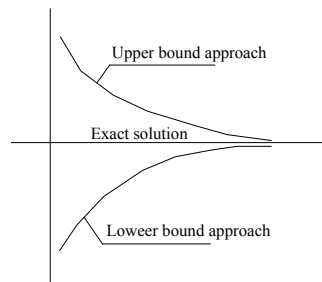

Fig.1: Primal-dual Optimization Method

Structural analysis calculates higher load capacities when taking the hardening effect into account. Bounded linear kinematic hardening model is basic model which gives quite realistic results. It could be applied for both limit and shakedown analysis, and the capacity of the structure could be achieved by low cycle fatigue or ratchetting criteria.

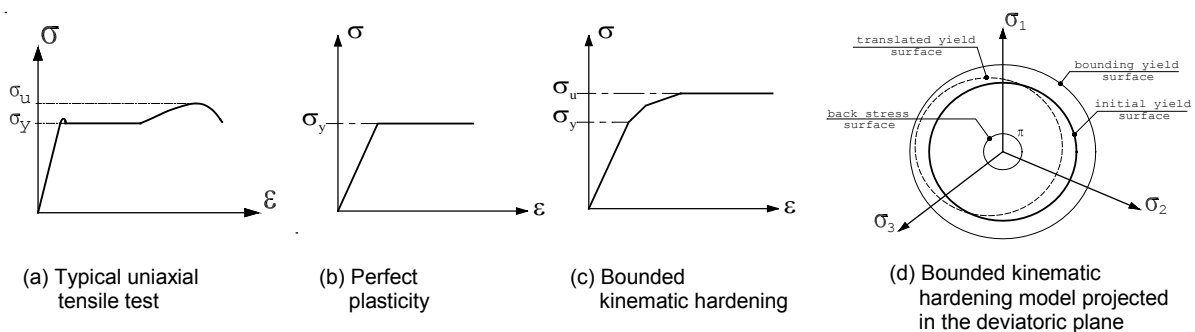

Fig. 2: Material Models

## Curriculum Vitae



Nachname / Name: Raue  
Vorname / First Name: Markus  
Titel / Title: M.Sc.

Hochschule / University: FH Aachen  
Standort / Location: Aachen  
Institut für Angewandte Polymerchemie (IAP)

Adresse der Hochschule / Address of the University: Worringer Weg 1, 52074 Aachen  
Telefon (Büro/Labor) / Phone (Office/Laboratory): 0241/80-26559  
Fax: 0241/80-22178  
E-Mail: mraue@mc.rwth-aachen.de  
Raumnummer (Büro/Labor) /  
Room Number (Office/Laboratory): 38B 002  
Fachbereich: Chemie und Biotechnologie

Name des Projektes / Name of the project: Intelligente Hydrogele  
Betreuender Professor an der FH Aachen /  
Professor attending to the  
University of Applied Sciences Aachen: Prof. Dr. Thomas Mang

Partneruniversität / Partner University: RWTH  
Betreuender Professor an der Universität /  
Professor attending to the University: Prof. Dr. Dr. Bernhard Blümich

Projektpartner / Project Partner: Prof. Dr. habil. Siegfried Stapf

## Design and characterisation of intelligent hydrogels

M. Raue<sup>\*1,2</sup>, S. Stapf<sup>3</sup>, Th. Mang<sup>1</sup>, B. Blümich<sup>2</sup>

<sup>1</sup> Institut für Angewandte Polymerchemie (IAP), Aachen University of Applied Sciences, 52074 Aachen, Germany

<sup>2</sup> Institut für Technische und Makromolekulare Chemie, RWTH Aachen, Germany

<sup>3</sup> Fakultät für Mathematik und Naturwissenschaften, TU Ilmenau; Germany

\* mraue@mc.rwth-aachen.de

Hydrogels are three-dimensional polymer networks which have the ability to keep a high amount of water. With an external stimulus like pH, polar or unpolar solution, ion concentration in solutions or temperature the hydrogels can change their shape. This behaviour has potential application as controlled drug released systems, sensors, actuators and membranes. The response is expressed in the deformation of the chemical designed network, resulting in swelling or shrinking of the gel samples. The fast swelling response in ionic hydrogels, where poly-(<sup>23</sup>Na-acrylate) is one of the most prominent examples, is the result of the osmotic pressure difference caused by the concentration of the <sup>23</sup>Na ions inside and outside the polymer network matrix. The swelling parameters can be controlled by the cross-linker type, the cross-linker concentration, the ionic strength and the charge density which influence the mechanical properties and the swelling kinetic.

The goal of this work is to synthesis new hydrogel types on the base of acrylic acid and maleic acid with his anhydride for a higher charge density and on the base of vinylphosphonic acid and of acryloylamido-2-methylpropanesulfonate for a higher ionic strength. The new hydrogels should be investigated relating to their swelling and shrinkage behaviour.

Furthermore another target is the manufacturing of switchable porous media, which has the ability to close and open their pores by an external stimulus. As previously said the main aim is the use of external stimuli pH and ion concentrations in solution with hydrogels based on acrylic acid and acryloylamido-2-methylpropanesulfonate and of the external stimulus temperature with a hydrogel based on hydroxypropylcellulose which has magnetic particles inside his matrix.

## Curriculum Vitae



Nachname / Name: Reisert  
Vorname / First Name: Steffen  
Titel / Title: Dipl.-Ing.

Hochschule / University: FH Aachen  
Standort / Location: Campus Jülich  
Institut für Nano- und Biotechnologien (INB)

Adresse der Hochschule / Address of the University: Ginsterweg 1, 52428 Jülich  
Telefon (Büro/Labor) / Phone (Office/Laboratory): 0241/6009-53239  
Fax: 0241/6009-53235  
E-Mail: reisert@fh-aachen.de  
Raumnummer (Büro/Labor) /  
Room Number (Office/Laboratory): I 105  
Fachbereich: Medizintechnik und Technomathematik

Name des Projektes / Name of the project: Entwicklung eines Sensorsystems zur Erfassung der  
Sterilisationswirkung von H<sub>2</sub>O<sub>2</sub>-Dampf

Betreuender Professor an der FH Aachen /  
Professor attending to the  
University of Applied Sciences Aachen: Prof. Dr.-Ing. Michael J. Schöning

Partneruniversität / Partner University: Universität Hasselt  
Betreuender Professor an der Universität /  
Professor attending to the University: Prof. Dr. Patrick Wagner

Projektpartner / Project Partner: SIG Combibloc Systems GmbH  
von Hoerner & Sulger GmbH



## Development of a sensor system for the validation of aseptic processes

S. Reisert<sup>1,\*</sup>, H. Henkel<sup>2</sup>, P. Friedrich<sup>3</sup>, H. Geissler<sup>4</sup>, M.J. Schöning<sup>1</sup>

<sup>1</sup> Institute of Nano- and Biotechnologies (INB), Aachen University of Applied Sciences, 52428 Jülich, Germany

<sup>2</sup> von Hoerner & Sulger GmbH, 68723 Schwetzingen, Germany

<sup>3</sup> Aseptiksysteme und Foodtechnologie, 52441 Linnich, Germany

<sup>4</sup> SIG Combibloc Systems GmbH, 52441 Linnich, Germany

\* reisert@fh-aachen.de

The use of hydrogen peroxide vapour (HPV) in aseptic filling processes is a widespread and well established method for the degermination of carton packages for foodstuff, beverages and medical equipment. Even though the mechanism of microbial inactivation by HPV is not completely understood, it offers various advantages over other methods due to its environmental compatibility. The efficiency of the process is depending, among others, on the temperature, the exposition time, the humidity level, the gas flow and particular on the hydrogen peroxide ( $H_2O_2$ ) concentration. Commonly, aseptic processes are characterised by means of microbial reduction tests, which are a time-consuming procedure. Therefore, a monitoring of the mentioned parameters is very important for the control of aseptic processes, though the high concentration of  $H_2O_2$  (up to 10 %v/v) and the elevated gas temperature (up to 250 °C) do not permit a monitoring with conventional methods.

One aim of the project was to design a sensor system for the on-line monitoring of the  $H_2O_2$  concentration. Therefore, a calorimetric-type gas sensor has been developed. With this sensor, a monitoring of  $H_2O_2$  in a range up to 10 %v/v and gas temperatures up to 300 °C is possible. Based on this sensor, a monitoring system by means of a handheld device for the on-line monitoring of the  $H_2O_2$  concentration has been developed.

On the other hand, the decomposition of  $H_2O_2$  during the evaporation phase is one important factor. At room temperature, the  $H_2O_2$  mainly decomposes to molecular oxygen and water. At higher temperatures, above 200 °C, the formation rate of radicals, like hydroxyl radicals ( $OH\cdot$ ) is increasingly accelerated. It is widely accepted, that this effect has a non-minor influence on the microbial reduction. Considering this, the evaluation of the microbial reduction process is rather more complex than monitoring the  $H_2O_2$  concentration, temperature, etc..

For this reason, a further approach for the real-time evaluation of microbial reduction during aseptic processes has to be adopted. One possibility for the evaluation of complex gas mixtures is described as the so called "electronic nose", which consists of an array of gas sensors with partial sensitivity and selectivity. If a gas mixture is presented to the sensor array, one will obtain a certain pattern of sensor signals, which is specific to that composition.

## Curriculum Vitae



Nachname / Name: Robinson  
Vorname / First Name: Alexander Edward  
Titel / Title: Dipl.-Ing.

Hochschule / University: FH Aachen  
Standort / Location: Aachen

Adresse der Hochschule / Adress of the University: Hohenstaufenallee 6, 52064 Aachen  
Telefon (Büro/Labor) / Phone (Office/Laboratory): 0241/6009-52309  
Fax: 0241/6009-52680  
E-Mail: robinson@fh-aachen.de  
Raumnummer (Büro/Labor)/  
Room Number (Office/Laboratory): 02113  
Fachbereich: Luft- und Raumfahrttechnik

Name des Projektes / Name of the project: Development and testing of hydrogen-fuelled combustion chambers for use in an ultra-micro gas turbine

Betreuender Professor an der FH Aachen /  
Professor attending to the  
University of Applied Sciences Aachen: Prof. Dr.-Ing. Harald Funke

Partneruniversität / Partner University: Université Libre de Bruxelles (ULB)  
Betreuender Professor an der Universität /  
Professor attending to the University: Prof. Dr. Patrick Hendrick

Projektpartner / Project Partner: Laser Bearbeitungs- und  
Beratungszentrum (LBBZ) NRW GmbH  
Royal Military Academy (RMA), Brüssel, Belgien

## Development and testing of hydrogen-fuelled combustion chambers for use in an ultra-micro gas turbine

A. E. Robinson<sup>\*1</sup>

<sup>1</sup> Aachen University of Applied Sciences, 52428 Jülich, Germany

\* robinson@fh-aachen.de

The increasing need for mobile power and the low energy density coupled with low power-to-weight ratio of today's accumulators leads to the search for alternative methods of generating electricity. One of these alternative options currently under research worldwide are ultra-micro gas turbines. Used within the Brayton cycle the much higher energy density of fuels can be effectively converted into electricity.

This work will deal with the development and testing of a combustion chamber especially designed for the potential use in a 1 kW ultra-micro gas turbine. The chamber is fuelled with gaseous hydrogen and works after the micromix diffusive burning principle. This principle is based on the fluid mechanic phenomenon of jets in cross flow. Being a non premixed concept the micromix burning principle has also the advantage of being inherently safe against flashback.

As the micromix principle was originally designed for the use within a combustion chamber of a full scale gas turbine, first step in the design process was the scaling down of this principle for a miniaturized application. For the experimental investigations a test rig was designed which allows visual access during operation and gives the possibility of pressurized testing.

Atmospheric tests included the following investigations for design and off-design conditions:

- influence of different chamber volumes
- ignition and extinction limits
- burning efficiency for different mass flows and different inlet conditions
- outlet temperature
- flame length

In parallel to the hot flow testing with the burner test rig the physical phenomenon of the burning principle was also further investigated by a water analogy test series. After careful consideration of all experimental results, one chamber variant was chosen for further testing under pressurized conditions.

The gathered results lead to a full characterization and mapping of the micro combustion chamber. Based on this data a second prototype burner with recuperative wall cooling and design focus on the possible integration into an ultra-micro gas turbine was built. Again a full series of atmospheric and pressurized tests were fulfilled including mass flow and Lambda variations from starting over part load to design conditions.

Altogether this thesis will give an insight into the challenges of developing and testing of a combustion chamber for miniaturized gas turbines fuelled with hydrogen.

This research project is funded by the German Ministry of Education and Research and experimental investigations are done at Aachen University of Applied Sciences in collaboration with the Department ATM of ULB.

## Curriculum Vitae



Nachname / Name: Rusack  
Vorname / First Name: Markus  
Titel / Title: Dipl.-Ing.

Hochschule / University: FH Aachen  
Standort / Location: Solar-Institut Jülich

Adresse der Hochschule / Adress of the University: Heinrich-Mußmann-Str. 5, 52428 Jülich  
Telefon (Büro/Labor) / Phone (Office/Laboratory): 0241/6009-53523  
Fax: 0241/6009-53570  
E-Mail: rusack@sjj.fh-aachen.de  
Raumnummer (Büro/Labor) /  
Room Number (Office/Laboratory): N02  
Fachbereich: Solar-Institut Jülich

Name des Projektes / Name of the project: Entwicklung und Untersuchung eines neuartigen Systems zur Nutzung der im Abwasser enthaltenen Wärme zur Versorgung von Wärmepumpen („Exairgie“)

Betreuender Professor an der FH Aachen /  
Professor attending to the  
University of Applied Sciences Aachen: Prof. Dr.-Ing. Bernhard Hoffschmidt

Partneruniversität / Partner University: Technische Universität Bergakademie Freiberg  
Betreuender Professor an der Universität /  
Professor attending to the University: Prof. Dr.-Ing. Dimosthenis Trimis

Projektpartner / Project Partner: Wallstein Ingenieur GmbH  
UGN-Umwelttechnik GmbH  
B+W Gesellschaft für innovative Produkte mbH

## Development of a new concept for using the heat content of sewage to run heat pumps

M. Rusack\*<sup>1</sup>, S. Röther<sup>1</sup>, J. Götttsche<sup>1</sup>, B. Müller<sup>1</sup>

<sup>1</sup> Solar-Institut Jülich, Aachen University of Applied Sciences, 52428 Jülich, Germany

\* rusack@sjj.fh-aachen.de

Content of the dissertation will be the evaluation of a heat recovery system for using sewage as a low-temperature source. The development of this system takes place at the Solar-Institut Jülich within the research project „Exairgie“ which is funded by the BMBF.

The sewage is an ideal heat source for supplying heat pumps, since it is relatively constant during the course of a day and also a year.

The developed system is for supplying domestic hot water in an one-family house and for heating. It is already installed in a one-family house and operational-test measurements takes place at the moment.

The concept affords to suck air through the sewage system by a ventilator. Therefore the existing internal sewer of the one-family house is used, so that cost-intensive earth moving is not necessary.

The air, as the heat transfer medium, enters the sewage system through the covers outside in the street and streams over the surface of the sewage. Thereby a combined heat- and mass transfer (water vapour) from the sewage to the cold air takes place. Simultaneously the system works as an air/earth-heat exchanger, so that there is an additional heat input from the surrounding soil. With a gas/liquid heat exchanger inside the house, the sensitive and the latent heat of the humid air can be transferred into the heat pump circuit. After cooling down, the air is lead back into the sewage system and into the ambient respectively.

The characteristic of the installed system is determined since the end of 2008. It already could be shown, that the system works without any malfunctions.

The heat pump has a heating power of 4.8 kW. The flow temperature for supplying domestic hot water is 52 °C, the flow temperature for heating is 40 °C. With the actual configuration, an average coefficient of performance of the system (COP) of 2.6 can be reached.

To increase the COP several optimisation steps concerning the system control and the reduction of pressure drop will be accomplished during the year 2009. An efficiency control will be carried out during the next heating period in 2009 / 2010.

The obtained data will be used to verify a simulation model of the system. It will be built with the software MATLAB Simulink and the toolbox Carnot. The evaluation of the heat recovery system will be carried out based on this model.

## Curriculum Vitae



Nachname / Name: Skorupa  
Vorname / First Name: Sascha  
Titel / Title: M.Sc.

Hochschule / University: FH Aachen  
Standort / Location: Campus Jülich

Adresse der Hochschule / Address of the University: Ginsterweg 1, 52428 Jülich  
Telefon (Büro/Labor) / Phone (Office/Laboratory): 0241/6009-53277  
Fax:  
E-Mail: skorupa@fh-aachen.de  
Raumnummer (Büro/Labor) /  
Room Number (Office/Laboratory): H4  
Fachbereich: Medizintechnik und Technomathematik

Name des Projektes / Name of the project: HiX for AGWS – XML-based history tracing  
in an actor-driven grid-enabled workflow system

Betreuender Professor an der FH Aachen /  
Professor attending to the  
University of Applied Sciences Aachen: Prof. Dr. Volker Sander

Partneruniversität / Partner University: University of Amsterdam  
Betreuender Professor an der Universität /  
Professor attending to the University: Prof. Dr. Adam Belloum

Projektpartner / Project Partner: Dipl.-Math. Mario Klöcker, Waagenbau Dohmen GmbH  
Dr. Achim Streit, Jülich Supercomputing Centre,  
Forschungszentrum Jülich GmbH

## XML-based history tracing in an actor-driven grid-enabled workflow system

S. Skorupa<sup>1,\*</sup>, F. Berretz<sup>1,\*\*</sup>

<sup>1</sup> Aachen University of Applied Sciences, 52428 Jülich, Germany

\*Skorupa@fh-aachen.de, \*\*Berretz@fh-aachen.de

Current e-Science infrastructures provide support for complex scientific processes that consist of orchestrated resources such as pure computational devices, specific applications, data repositories, or scientific instruments. In order to support the orchestration of scientific tasks, Grid middleware platforms like UNICORE offer a workflow management system as an enactment service build on top of the middleware. The most common approach in Grid workflow management systems supports the push-pattern of the known workflow resource patterns. Here, a software agent, e.g. the workflow engine, actively exercises control about the progress of a workflow by pushing the individual tasks to the selected resources according to the dependencies, provided by the workflow description. Various advances to the management system have been performed to assure data or process oriented provenance or to allow for a late binding of tasks to resources. A fundamental barrier remains with respect to the acceptance: The push-model requires that a service receives a particular level of control about the resources. While this barrier is addressed by the foundation of virtual organizations and by the introduction of Service Level Agreements, a pull-based approach could offer new perspectives for e-Science infrastructures. Here, resources can not only actively select which work item they wish to commence next, it also allows the integration of human interaction patterns according to emerging standards such as WS-HumanTask.

The project's idea is to develop a pull-based approach for workflow management in Grid environments. The approach was motivated by a specific provenance concept in a single e-Government application domain that relies on layered, digitally signed XML-documents that traces the history of operations in a legally usable form. It generalizes the idea of using layered, digitally signed XML-documents to trace the progress of a workflow and introduces a pull-based approach to Grid workflow management by an intermediary that mediates between workflow instances and resources.

## Curriculum Vitae



Nachname / Name: Thenent  
Vorname / First Name: Nils Elias  
Titel / Title: Dipl.-Ing.

Hochschule / University: FH Aachen  
Standort / Location: Aachen

Adresse der Hochschule / Address of the University: Hohenstaufenallee 6, 52064 Aachen  
Telefon (Büro/Labor) / Phone (Office/Laboratory): 0241/6009-52370  
Fax:  
E-Mail: thenent@fh-aachen.de  
Raumnummer (Büro/Labor) /  
Room Number (Office/Laboratory): O2115  
Fachbereich: Luft- und Raumfahrttechnik

Name des Projektes / Name of the project: Hydrostatic propeller drive

Betreuender Professor an der FH Aachen /  
Professor attending to the  
University of Applied Sciences Aachen: Prof. Dr. Peter Dahmann

Partneruniversität / Partner University: to be defined  
Betreuender Professor an der Universität /  
Professor attending to the University: to be defined

Projektpartner / Project Partner: IFAS, RWTH;  
Alexander Schleicher Flugzeugbau;  
GL Hydraulik



## Hydrostatic propeller drive

P. Dahmann<sup>1</sup>, N. E. Thenent\*<sup>1</sup>

<sup>1</sup> Aachen University of Applied Sciences, 52066 Aachen, Germany

\* thenent@fh-aachen.de

This research project aims to develop a hydrostatic drive for a motor glider application. The main focus is the optimization of the hydraulic system regarding mass and efficiency.

Currently, high performance motor gliders use retractable propellers which are mounted above the fuselage for take off and to return to the landing field. For the most part of the flight, the propeller is hidden in the fuselage, giving the airplane its clean aerodynamic shape. Once the propeller is extended the glide ratio is significantly reduced. Therefore it is very desirable to ensure that the engine starts running immediately, so the loss of altitude is reduced. The driving combustion engine is either mounted on the extendable tower behind the cockpit, or buried in the fuselage. In the first case the propeller is directly flanged to the engine, in the latter case, the propeller is driven via a belt drive. Both installations require the propeller to be extended before the engine can be started, which is potentially risky in case the engine does not fire-up. Additionally there is no room in the design phase to vary the propeller's position, which could improve the propeller's efficiency.

By using a hydrostatic propeller drive, the mechanical power transmission from the engine to the propeller is replaced with a hydraulic system, consisting of a pump, a hydraulic motor and a couple of other components. Its first advantage is that the only required connections to the propeller are two hydraulic hoses, allowing a propeller installation at almost any desired place on the airplane. Secondly a simple valve set-up would allow for a start-up of the engine without extending the propeller. Once stable engine operation is achieved the pilot can change to the powered flight mode, being assured, that the propeller will actually turn. That provides a significant improvement in flight safety.

As the application in an airplane requires minimum mass, one of the challenges is the minimization of hydraulic oil volume and the component masses. That implies the requirement to carefully control the heat balance of the system. A maximized overall efficiency of the power transmission is the key to the successful development of a proof of concept prototype, which can be tested in flight.

## Curriculum Vitae



Nachname / Name: Turek  
Vorname / First Name: Monika  
Titel / Title: Dipl.-Ing.

Hochschule / University: FH Aachen  
Standort / Location: Campus Jülich  
Institut für Nano- und Biotechnologien (INB)

Adresse der Hochschule / Address of the University: Ginsterweg 1, 52428 Jülich  
Telefon (Büro/Labor) / Phone (Office/Laboratory): 0241/6009-53215  
Fax: 0241/6009-53235  
E-Mail: turek@fh-aachen.de  
Raumnummer (Büro/Labor) /  
Room Number (Office/Laboratory): H 311  
Fachbereich: Medizintechnik und Technomathematik

Name des Projektes / Name of the project: Entwicklung eines siliziumbasierten (Bio-) Sensors für den Nachweis von Cyanid in der Umweltanalytik

Betreuender Professor an der FH Aachen /  
Professor attending to the  
University of Applied Sciences Aachen: Prof. Dr.-Ing. Michael J. Schöning

Partneruniversität / Partner University: Philipps-Universität Marburg  
Betreuender Professor an der Universität /  
Professor attending to the University: Prof. Dr. Michael Keusgen

Projektpartner / Project Partner: Institut für Bio- und Nanosysteme,  
Forschungszentrum Jülich GmbH  
Fachhochschule Bonn-Rhein-Sieg  
Institut für Biochemie und Molekularbiologie,  
RWTH Aachen

## Detection of cyanide by means of silicon-based semiconductor sensors

M. Turek<sup>1,2\*</sup>, L. Ketterer<sup>3</sup>, J. Schubert<sup>2</sup>, P. Krüger<sup>4</sup>, M. Keusgen<sup>3</sup>, M.J. Schöning<sup>1,2</sup>

<sup>1</sup> Institute of Nano and Biotechnologies (INB), Aachen University of Applied Sciences, 52428 Jülich, Germany

<sup>2</sup> Institute of Bio- and Nanosystems (IBN-2), Research Centre Jülich GmbH, 52425 Jülich, Germany

<sup>3</sup> Institute of Pharmaceutical Chemistry, Philipps-University Marburg, 35037 Marburg, Germany

<sup>4</sup> RWTH Aachen, Institute for Biochemistry and Molecular Biology, 52074 Aachen, Germany

\* turek@fh-aachen.de

Cyanide and its derivatives play an important role in environmental monitoring; already a few mg cyanide/kg human weight can lead to death. In addition, cyanogenic glycosides can be found in more than 2500 plants naturally. At the same time, due to its chemical properties cyanide is used for several industrial purposes, such as the extraction of silver or gold.

To determine cyanide in aqueous solutions, semiconductor-based (bio-)chemical sensors are highly attractive for a possible "online" monitoring because of their excellent electrochemical properties and potential of miniaturisation.

Two sensor concepts have been developed in this work: capacitive enzyme-modified EIS (electrolyte-insulator-semiconductor) structures and potentiometric Ag-chalcogenide glass-based  $\mu$ ISEs (micro-ion-selective electrode) or Ag-halogenide ISEs for the detection of cyanide. The enzyme-modified biosensor consists of a field-effect structure with a pH-sensitive transducer layer on which the cyanide-selective enzyme *cyanidase* has been immobilised. The detection method is based on the local pH shift due to the catalytic conversion of cyanide by *cyanidase* to ammonia and formic acid. The ISE-type cyanide sensors have been fabricated by means of silicon planar technology in combination with pulsed laser deposition or thick-film processes, respectively. The mechanism of cyanide detection is based in this case on the complex-forming reaction between  $\text{Ag}^+$  ions in the transducer material and  $\text{CN}^-$  ions in the analyte, resulting in a change of the surface potential. Fig. 1 shows the two sensor concepts.

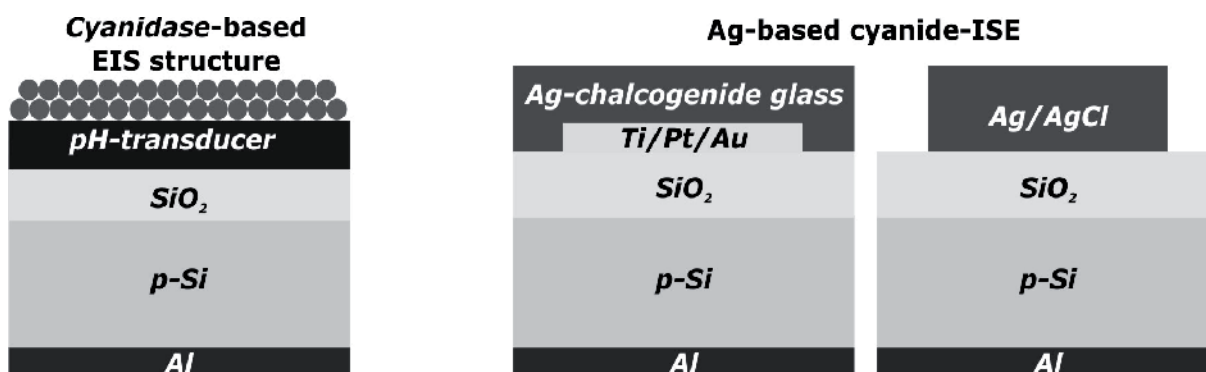
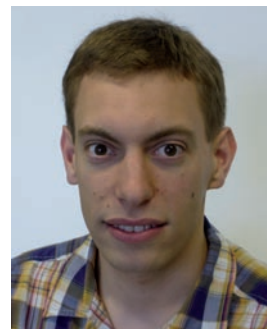

Fig. 1: Semiconductor-based concepts of a cyanide sensor: cyanide biosensor (left), cyanide Ag-chalcogenide glass- and Ag/AgCl sensor (middle, right)

## Curriculum Vitae



Nachname / Name: Werner  
Vorname / First Name: Carl Frederik  
Titel / Title: Dipl.-Ing.

Hochschule / University: FH Aachen  
Standort / Location: Campus Jülich  
Institut für Nano- und Biotechnologien (INB)

Adresse der Hochschule / Address of the University: Ginsterweg 1, 52428 Jülich  
Telefon (Büro/Labor) / Phone (Office/Laboratory): 0241/6009-53239  
Fax: 0241/6009-53235  
E-Mail: f.werner@fh-aachen.de  
Raumnummer (Büro/Labor) /  
Room Number (Office/Laboratory): I 105  
Fachbereich: Medizintechnik und Technomathematik

Name des Projektes / Name of the project: „Bio-LAPS“ Optimierung des Betriebs Biogasfermenters mit Hilfe eines Feldeffekt-Biosensors auf Basis eines lichtadressierbaren potentiometrischen Sensors (LAPS)

Betreuender Professor an der FH Aachen /  
Professor attending to the  
University of Applied Sciences Aachen: Prof. Dr.-Ing. Michael J. Schöning

Partneruniversität / Partner University: Philipps-Universität Marburg  
Betreuender Professor an der Universität /  
Professor attending to the University: Prof. Dr. Michael Keusgen

Projektpartner / Project Partner: Institut für Bio- und Nanosysteme,  
Forschungszentrum Jülich GmbH

## Bio-LAPS – optimising of the operation of a biogas fermenter by means of a field-effect biosensor based on a light-addressable potentiometric sensor (LAPS)

C.F. Werner<sup>1,2\*</sup>, S. Groebel<sup>1</sup>, H. Spelthahn<sup>1,2</sup>, T. Wagner<sup>1,3</sup>, M.E.M. Baumann<sup>1</sup>, M.J. Schöning<sup>1,2</sup>

<sup>1</sup> Institute of Nano- and Biotechnologies (INB), Aachen University of Applied Sciences, 52428 Jülich, Germany

<sup>2</sup> Institute of Bio- and Nanosystems, Research Centre Jülich GmbH, 52425 Jülich, Germany

<sup>3</sup> Tohoku University, Department of Electronic Engineering, Japan

\* f.werner@fh-aachen.de

In methane-producing biogas fermenters the onset of the 3<sup>rd</sup> phase, when acetogen bacteria start to feed on the organic acids, is one of the most critical points of the whole process. Hence, the information of the successful start of this phase is of crucial importance to the operating user of professional plants. Hitherto, there is no easy analytical tool available which provides this information. The purpose of this study is the development of a novel field-effect biosensor based on a light-addressable potentiometric sensor ("Bio-LAPS") to monitor the metabolic activity and vitality of acetogen bacteria.

The Bio-LAPS is a cooperation between the laboratory of plant biotechnology and the laboratory of chemical sensors and biosensors.

In this work, a LAPS set-up, as shown in figure 1, is been developed. The LAPS represents a semiconductor-based chemical sensor with the advantage of detecting the local pH value with a spatial resolution by specific illumination of the sensor area under test. The sensor surface should partly be immobilised with acetogenic bacteria. This, the acidification of these bacteria during their metabolism can be detected. With this information about the metabolic activity the set-up should be able to get on-line information about the anaerobic digestion the of biogas fermenter.

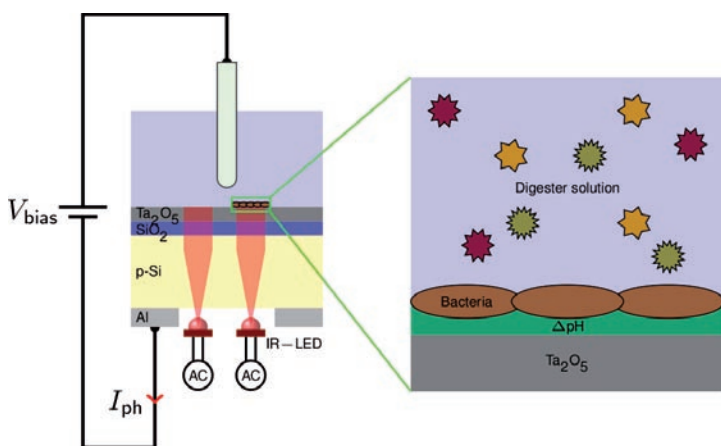

Fig. 1: Light-addressable potentiometric sensor set-up with bacteria, measuring the acidification of the bacteria during their metabolism in the biogas fermenter.

# Impressum / Imprint

Tagungsband der 2. Graduiertentagung der FH Aachen am 5. November 2009

Proceedings from the 2<sup>nd</sup> Graduate Symposium, FH Aachen – University of Applied Sciences – Germany, November 5<sup>th</sup>, 2009

## **Veranstalter / Organizer**

Dipl.-Ing. Silvia Kowollik

Vertreterin der Doktorandinnen und Doktoranden

Prof. Dr. Christiane Vaeßen

Prorektorin für Forschung, Entwicklung und Technologietransfer

Prof. Dr. Michael J. Schöning

Institut für Nano- und Biotechnologien (INB)

## **Redaktion / Editorial**

Dipl.-Ing. Simone Groebel

Dipl.-Ing. Silvia Kowollik

Silvia Crummenerl

Prof. Dr. Michael J. Schöning

## **Layout und Satz / Layout**

Silvia Crummenerl, FH Aachen, Dez. Z

## **Druck / Print**

Print Production M. Wolff GmbH, Aachen

## **Auflage / Circulation**

200 Stück

## **Bildnachweis / Picture Credits**

Die Bilder und Grafiken wurden jeweils von den Autoren der Exposés selbst bereitgestellt.

Fotos Deckblatt und Umschlagseite innen: FH Aachen

Aachen, Oktober 2009



