

Determining Suitable Spacings and Distances for Self-tapping Screws by Experimental and Numerical Studies

Thomas Uibel¹, Hans Joachim Blaß²

KEYWORDS: Self-tapping screws, Splitting behaviour, Insertion tests

EXTENDED ABSTRACT

In recent years self-tapping screws have been increasingly used for connections or reinforcements in timber engineering. Most self-tapping screws can be arranged maintaining only small spacings and distances without risking a consequential splitting failure of the timber member. To avoid significant crack growth and splitting failure minimum values for spacings, end and edge distances as well as for the corresponding minimum timber thickness have to be determined. These requirements are important for the design of joints with self-tapping screws. Figure 1 shows a typical splitting failure. As a consequence of splitting or of significant crack growth the load carrying capacity of the joint or of the member itself can be reduced so far that the timber member has to be discarded. The determination of the required spacing, edge and end distances for self-tapping screws necessitates numerous and comprehensive 'conventional' insertion tests.

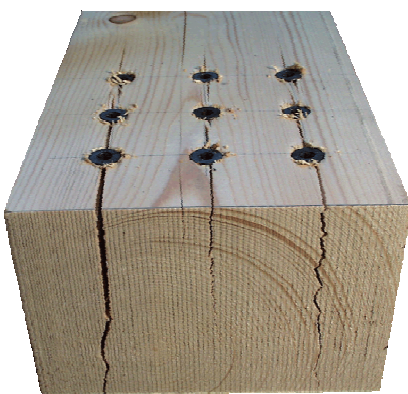

Figure 1: Splitting failure

¹ Thomas Uibel, Holzbau und Baukonstruktionen, Karlsruher Institut für Technologie, KIT-Campus Süd, R.-Baumeister-Platz 1, 76131 Karlsruhe, Germany. Email: uibel@kit.edu

² Hans Joachim Blaß, Holzbau und Baukonstruktionen, Karlsruher Institut für Technologie, KIT-Campus Süd, R.-Baumeister-Platz 1, 76131 Karlsruhe, Germany. Email: blass@kit.edu

For five types of self-tapping screws 326 conventional insertion tests were carried out. It was the aim of the tests to determine the minimum timber thickness which is necessary to avoid undue splitting by arranging the screws with the same spacings, end and edge distances as for nails with predrilled holes given in the German design code DIN 1052. The test results show that the aimed spacings and distances are possible for all types of examined self-tapping screws, but the corresponding timber thickness is very different depending on the screw type and diameter. The reasons for these discrepancies are differences in screws' geometry or in special features decreasing the torsional resistance e.g. the shape of the screw tips and their effects of pre-drilling. In consequence the results of conventional insertion tests cannot be transferred to other types of screws or even to screws of different diameter. Furthermore the evaluation of insertion tests is ambiguous because it is only based on externally visible cracks. For these reasons the extent of tests and the effort involved in these tests is large.

To offer a solution to this problem a calculation model on the basis of the Finite Element method was developed in a research project at Karlsruhe Institute of Technology (KIT). The model allows an estimation of the splitting behaviour of timber during the insertion process. By that, the big extent of iterative insertion tests can be reduced to a much smaller amount of tests necessary to confirm the results of the calculations. For laterally loaded screws additional load carrying capacity tests with joints are indispensable.

By using a numerical calculation model on the basis of the Finite Element Method (FEM) almost all of the material-specific and geometry-specific influences on the splitting behaviour can be covered. But so far it is not possible to model the insertion process directly using the Finite Element Method particularly with regard to the screw-specific influences like e.g. the predrilling effect of screw tips. Because of these difficulties a new test method has to be developed which allows quantifying the effects of screw-specific features on the splitting forces during insertion. For the new test method a two-part specimen of solid wood, glued laminated timber or laminated veneer lumber is required, see Figure 2. The two parts of the specimen are connected with measure-

ment screws, which are tightened with a defined force. With the help of the measurement screws it is possible to measure axial forces. The examined self-tapping screw is driven into the interface of the two-part specimen. The test method allows displaying the forces acting on the test specimen, measured at the measuring points, over the penetration depth during the insertion process.

For further comparisons the mean total force is defined. This is the sum of all measured forces exerted on the six measurement screws over the penetration depth, divided by the screw length. To enable a comparison between the test results of the different series the mean total force of one screw type is used as a reference value. The chosen comparison of indices also allows contrasting the results of the new test method with the minimum timber thickness determined by conventional insertion tests. A visualisation of this comparison is given for three test series with screw types A, B and C in the bar chart in Figure 3. It shows the good correspondence between the results of the two test methods. Thence the method allows a direct evaluation of a screw's effect on the splitting behaviour by comparing it with the results of parallel tests involving reference screws whose influence on the splitting behaviour has already been established. Knowing the size of the resulting split area is important to evaluate the risk of splitting during the insertion process and hence to determine the required timber thicknesses, spacings, end and edge distances. Therefore a numerical model is developed to calculate the resulting crack area for differently spaced screws, for different end distances as well as for different timber cross-sections. Material-specific influences on the splitting behaviour - like timber density, screw or annual ring orientation - are taken into consideration. In the FE model the tensile strength perpendicular to the grain that represents a relevant factor for splitting was simulated by using non-linear spring-elements whose material behaviour was determined on the basis of tests using CT specimens. So far it is not possible to model the insertion process directly using FEM. To solve this modelling problem the insertion of the screw is modelled by an equivalent moving load which is determined on the basis of the results of the new test method. For this purpose the tests are simulated with a three dimensional Finite Element model.

The FE model for calculation of split areas has to be calibrated and to be verified. Therefore the cracks were visualized in insertion tests by dyeing the relevant areas. The size of the split area caused by the insertion of the screw is quantified using a measuring projector. Figure 4 shows simulated split areas over the test results for nine series. The simulated crack areas mostly proved to correspond with the test results and the shapes of split areas also correspond qualitatively. The developed method allows a calculation of required timber cross sections, spacings and end distances for different screws as well as an estimation of expected splitting phenomena. This offers a basis for a realistic calculation of the load carrying capacity of joints in the case of failure by splitting.

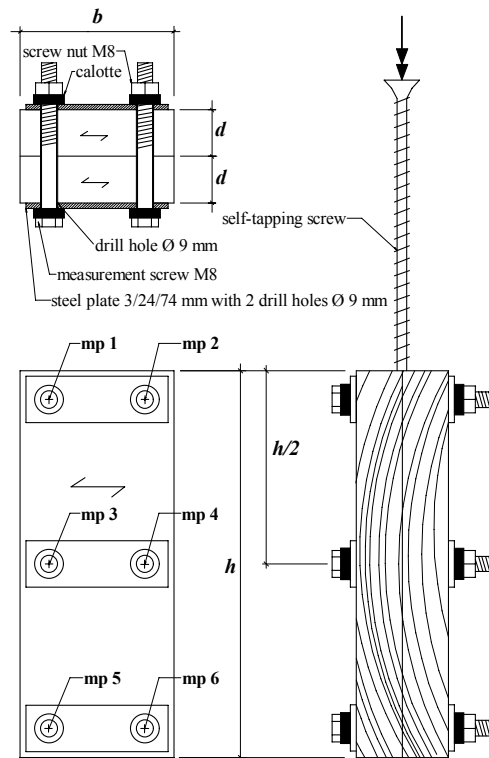

Figure 2: Test set-up with measuring points (mp) 1 to 6

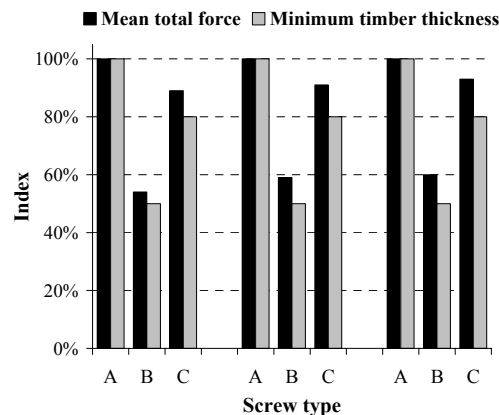

Figure 3: Mean total force and minimum timber thickness for three test series

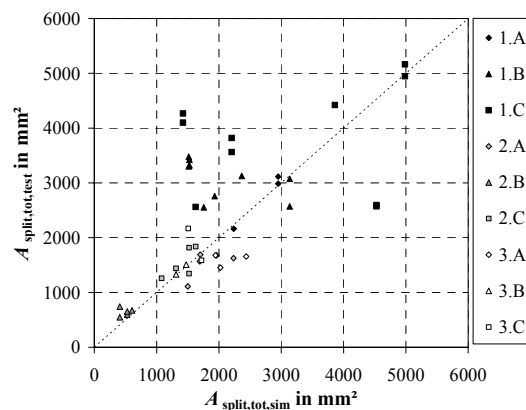

Figure 4: Test results over simulated split areas

Determining Suitable Spacings and Distances for Self-tapping Screws by Experimental and Numerical Studies

Thomas Uibel¹, Hans Joachim Blaß²

ABSTRACT: For the determination of suitable spacings, end and edge distances as well as of the corresponding timber thickness for self-tapping screws extensive conventional insertion tests have to be carried out. In order to reduce the effort of these tests a calculation method was developed which allows an estimation of the splitting behaviour of timber during the insertion process. Therefore the forces exerting on the timber during the insertion were determined using a new test method.

KEYWORDS: Self-tapping screws, Splitting behaviour, Insertion tests

1 INTRODUCTION

In recent years self-tapping screws have been increasingly used for connections or reinforcements in timber engineering. Most self-tapping screws can be arranged maintaining only small spacings and distances without risking a consequential splitting failure of the timber member. To avoid significant crack growth and splitting failure minimum values for spacings, end and edge distances as well as for the corresponding minimum timber thickness have to be determined. These requirements are important for the design of joints with self-tapping screws and have to be defined in technical approvals or to be examined regarding structural design codes [1] [2].

Figure 1 shows a typical splitting failure due to too small spacings and distances. As a consequence of splitting or of significant crack growth the load carrying capacity of the joint or of the member itself can be reduced so far that the timber member has to be discarded. The determination of the required spacing, edge and end distances for these screws necessitates numerous and comprehensive insertion tests. Yet the results of such tests cannot be transferred to other types of screws or even to screws of different diameter because of differences in shape or geometry.

To offer a solution to this problem a calculation model on the basis of the Finite Element method was developed in a research project [3] at Karlsruhe Institute of

Technology (KIT). The model allows an estimation of the splitting behaviour of timber during the insertion process. By that, the big extent of iterative insertion tests can be reduced to a much smaller amount of tests that is necessary to confirm the results of the calculations. For laterally loaded screws additional load carrying capacity tests with joints are indispensable.

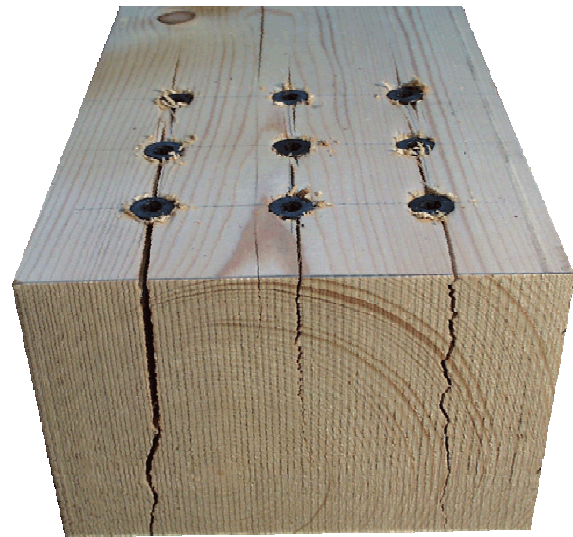

Figure 1: Splitting failure due to too small spacings and distances

2 CONVENTIONAL INSERTION TESTS

Concerning spacings and distances screws are usually treated like nails. Table 1 shows minimum values for spacings, edge and end distances which are provided by the German design code DIN 1052 [1]. The associated definitions which are similar to EN 1995-1-1 [2] are specified in Figure 2.

¹ Thomas Uibel, Holzbau und Baukonstruktionen, Karlsruher Institut für Technologie, KIT-Campus Süd, R.-Baumeister-Platz 1, 76131 Karlsruhe, Germany. Email: uibel@kit.edu

² Hans Joachim Blaß, Holzbau und Baukonstruktionen, Karlsruher Institut für Technologie, KIT-Campus Süd, R.-Baumeister-Platz 1, 76131 Karlsruhe, Germany. Email: blass@kit.edu

Table 1: Minimum spacings, end and edge distances for nails, according to German DIN 1052:2008 [1]

Spacing or distance	without predrilled holes ¹⁾		with predrilled holes
	$d < 5 \text{ mm}$	$d \geq 5 \text{ mm}$	
a_1	$(5+5 \cos \alpha) d$	$(5+7 \cos \alpha) d$	$(3+2 \cos \alpha) d$
a_2	$5 d$	$5 d$	$3 d$
$a_{1,t}$	$(7+5 \cos \alpha) d$	$(10+5 \cos \alpha) d$	$(7+5 \cos \alpha) d$
$a_{1,c}$	$7 d$	$10 d$	$7 d$
$a_{2,t}$	$(5+2 \sin \alpha) d$	$(5+5 \sin \alpha) d$	$(3+4 \sin \alpha) d$
$a_{2,c}$	$5 d$	$5 d$	$3 d$
1) for timber of a characteristic density $\rho_k \leq 420 \text{ kg/m}^3$			

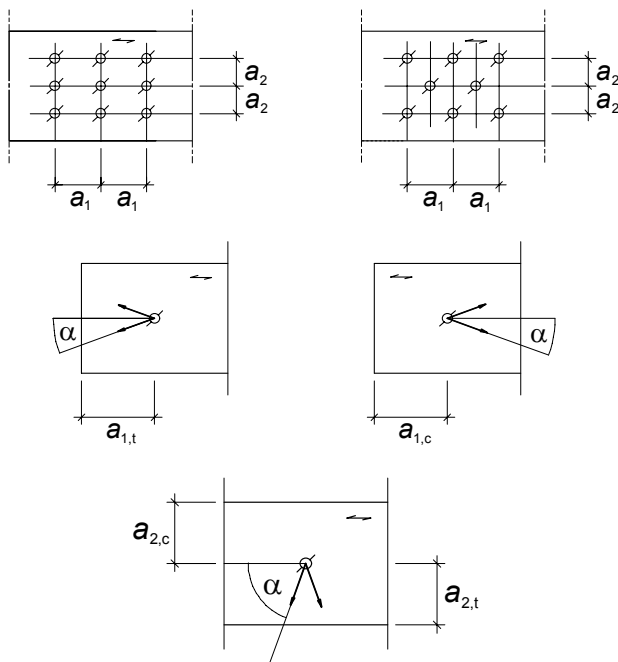

Figure 2: Definition of spacings, end and edge distances, according to DIN 1052:2008 [1]

Often, self-tapping screws may be arranged with smaller spacings and distances than specified in EN 1995-1-1 or in DIN 1052 without risking a consequential splitting failure of the member. This depends e.g. on the shape of the screw tip, the screw head and the existence of special features decreasing the torsional resistance to insertion. Figure 3 and Figure 4 show the great variety of screw tips and heads.

As yet insertion tests (here called “conventional insertion tests”) are carried out in order to determine suitable spacings and distances. For a conventional insertion test the examined self-tapping screw is inserted without pre-drilling as usual in practice. The screw head should be flush with the timber surface. The test specimen should be made of sawn timber of higher density, e.g. for European spruce (*Picea abies*) $\rho \geq 480 \text{ kg/m}^3$.



Figure 3: Different shapes of tips of self-tapping screws

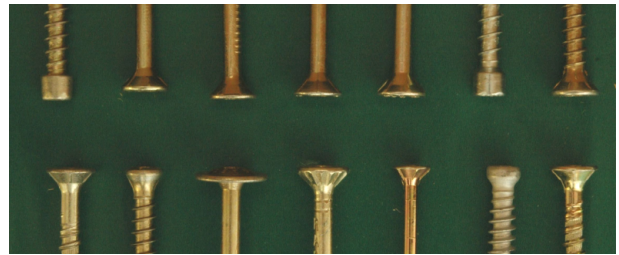

Figure 4: Different heads of self-tapping screws

To identify possible combinations of spacings, end distances and cross-sections it is necessary to test different configurations iteratively. Yet the results of such tests cannot be transferred to other types of screws because of their different geometries and shapes. A transfer of the results to similar screws of different diameter is also not possible. This means that a great amount of extensive insertion tests have to be carried out.

Table 2 shows the results of 326 conventional insertion tests with five types of self-tapping screws of four manufacturers [4]. The tests were carried out with different configurations, so that altogether 1125 screws were used. It was the aim of the tests to determine the minimum timber thickness necessary to avoid undue splitting by arranging the self-tapping screws with the same spacings, end and edge distances as for nails with predrilled holes given in Table 1, last column.

Table 2: Test-results of conventional insertion tests

Producer/ Type	d mm	ρ_{mean} kg/m ³	n	t_{min} mm	
A	5	487	51	24	$4,8 \cdot d$
A-2	5	483	56	30	$6 \cdot d$
A	8	477	35	80	$10 \cdot d$
A	10	497	12	100	$10 \cdot d$
A	12	449	42	96	$8 \cdot d$
B	8	497	13	40	$5 \cdot d$
C	6	504	51	42	$7 \cdot d$
C	8	484	44	64	$8 \cdot d$
D	8,9	494	22	127	$14,3 \cdot d$

The mean density (at normal climate, 20°C/65% RH) of all specimens made of European spruce (*Picea abies*) or fir (*Abies alba*) was $\rho_m = 484 \text{ kg/m}^3$ and the mean moisture content $u_m = 12,0 \%$. The determined minimum timber thickness for each screw type and diameter is given in Table 2.

The results of the tests are summed up in the following. Spacings, end and edge distances as given in the last column of Table 1 are possible for all types of the examined self-tapping screws, but the corresponding timber thickness is different depending on the screw type and diameter. For some types of screws restrictions concerning the end distance $a_{1,c}$ and the spacing a_1 need to be set. For screws whose shapes and geometries diverge from each other a different splitting behaviour was observed. Furthermore for screws of the same diameter and similar proportional geometry it was possible to observe significant differences concerning the suitable timber thickness. The reasons for this discrepancy are differences in special features decreasing the torsional resistance e.g. the shape of the screw tips and their effects of pre-drilling.

A comparison of the determined timber thickness for screws of types A, B and C of 8 mm in diameter shows that a transfer of test results from one screw type to another is not possible even for screws of the same diameter. Besides it is not possible to transfer test results to screws of the same type but of different diameters. A look at the test results of screws of type A can illustrate this fact. For screws of type A with $d = 12 \text{ mm}$ the required timber thickness is smaller than for screws A of 8 or 10 mm in diameter.

To adequately consider the material specific influences of timber on the splitting behaviour, numerous tests are required. Besides the crack growth is influenced by unknown internal stresses of the test specimens. These are the reasons for the poor reproducibility of test results of conventional insertion tests. Furthermore the evaluation of insertion tests is ambiguous because it is only based on externally visible cracks. For these reasons the extent of tests and the effort involved in these tests is large.

3 NEW METHOD FOR DETERMINING SPLITTING BEHAVIOUR

3.1 GENERAL

Until recently general scientific research concerning the splitting behaviour of timber during the insertion of fasteners was predominantly focused on nails [5-10].

For the determination of suitable spacings, end and edge distances as well as of the corresponding timber thickness for self-tapping screws a lot of extensive conventional insertion tests have to be carried out. In order to reduce the effort of these tests it was the objective of a research project to develop a calculation method which allows an estimation of the splitting behaviour of timber during the insertion process.

The influences which are important for the splitting behaviour have to be taken into account. They can be classified into three groups:

- Material-specific influences (e.g. kind of wood, density, width of growth rings and their orientation, moisture content)
- Geometry-specific influences (spacings, end and edge distances in relation to the screw diameter, position and number of screws)
- Fastener-specific influences (e.g. shape of the screw tip, screw head, further features to decrease the torsional resistance)

By using a numerical calculation model on the basis of the Finite Element Method almost all of the material-specific and geometry-specific influences on the splitting behaviour can be covered. But so far it is not possible to model the insertion process directly using the Finite Element Method, particularly with regard to the screw-specific influences. The correct numerical characterisation of the pre-drilling effect of screw tips and further features is problematic. Because of these difficulties a new method was developed which allows quantifying the effects of screw-specific features on the splitting forces during insertion.

3.2 TESTING SCREW-SPECIFIC INFLUENCES

In order to determine the fastener-specific influences on the splitting behaviour a new test method was developed for measuring forces affecting the member perpendicular to the grain during the insertion process [1, 11, 12].

For the new test method a two-part specimen of solid wood, glued laminated timber or laminated veneer lumber is required. The two-part specimen is made of one cross-section by sawing it parallel to the grain, as shown in Figure 5. The two parts of the test specimen are connected with screws which are used as measuring elements. These measurement screws are tightened with a defined force. A strain gauge is embedded into a hole drilled at the centre of the measurement screw with an adhesive. By calibrating the strain gauge embedded in the measurement screw it is possible to measure axial forces. The examined screw is driven into the interface of the two parts of the test specimen as shown in Figure 6 and Figure 7.

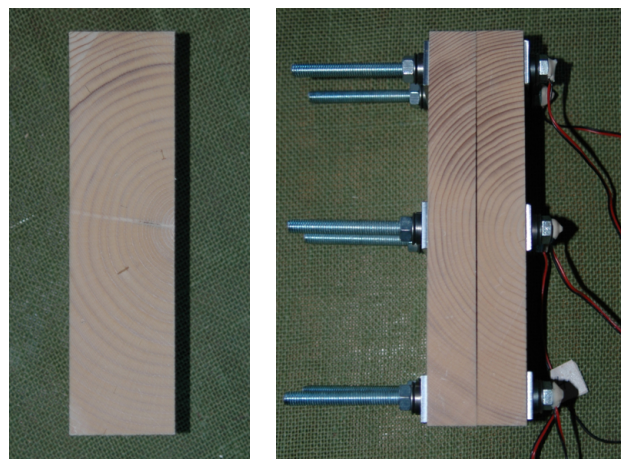

Figure 5: A two-part test specimen connected with measurement screws (right) made of one cross section (left)

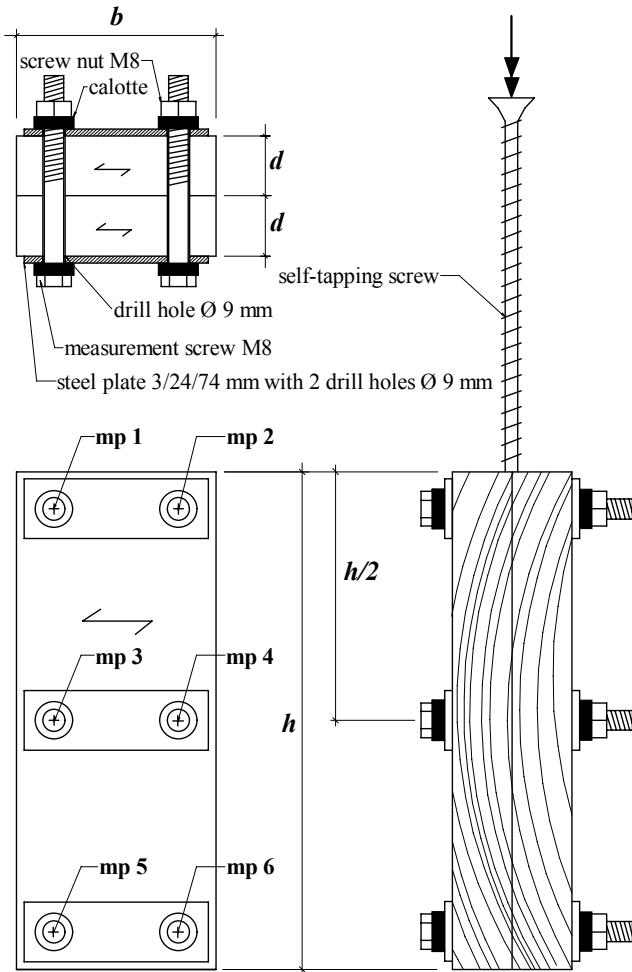

Figure 6: Test configuration, position of measuring points (mp) 1 to 6

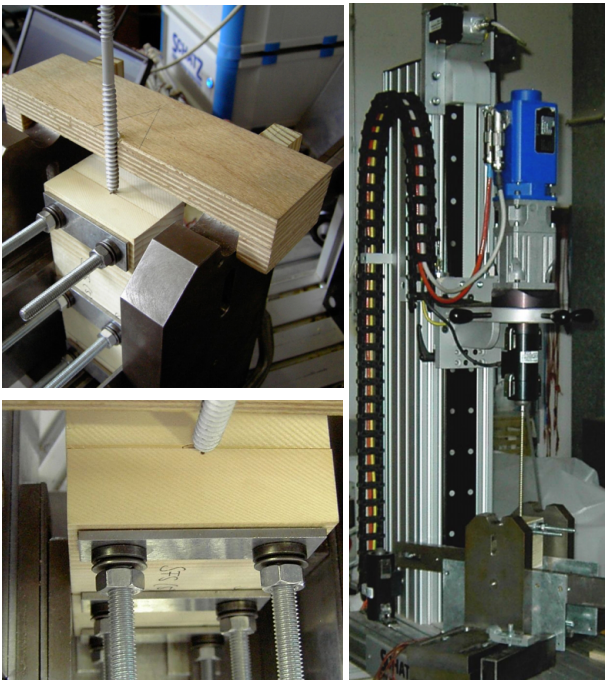

Figure 7: Test set-up, using a screw-testing machine for the insertion (right)



Figure 8: Opened test specimen after the test

For the insertion process a screw-testing machine (Figure 7, right) is used, so that the rotation speed is constant and it is possible to measure the screw insertion moment as well as to control the penetration depth. The screw is inserted using a template to avoid an inclination of the screw. After the insertion the indentation depth of the root of the screw thread should be similar on both parts of the test specimen, as shown in the example of an opened test specimen in Figure 8.

The test method allows displaying the forces acting on the test specimen, measured at the measuring points, over the penetration depth during the insertion process. The position of the measurement screws (measuring points) 1 to 6 are marked in Figure 6.

To determine the splitting behaviour for the screws of manufactures A, B, and C three test series were carried out. In each series screws of the three different types (A, B, C) with 8.0 x 200 mm in dimension were tested. The parameter of the specimens are summarised in Table 3. The test results are presented in Table 4.

It was possible to determine significant force-penetration depth curves for the different types of screws. Figure 9 to Figure 11 show the results of one test series (series 1). In order to compare the test results directly specimens with the same material properties were used in the different sub-series (e.g. 1-A, 1-B, 1-C). It was simple to realise this by using one scantling for the production of several specimens, which were allocated to the different sub-series.

For further comparisons the mean total force $F_{m,tot}$ is defined. This is the sum of all measured forces ($F_{mp,i}$) exerted on the six measurement screws ($i = 1$ to 6) over the penetration depth (ℓ_{pd}), divided by the nominal screw length ($\ell_{sr,nom}$):

$$F_{m,tot} = \frac{1}{\ell_{sr,nom}} \int_0^{\ell_{pd}} (F_{mp,1}(x) + \dots + F_{mp,i}(x) + \dots + F_{mp,n}(x)) dx \quad (1)$$

where $F_{m,tot}$ = mean total force, $F_{mp,i}$ = force at the measuring point i , ℓ_{pd} = total penetration depth, $\ell_{sr,nom}$ = nominal screw length.

Instead of the nominal screw length $\ell_{sr,nom}$ the forces can be set in relation to the real screw length $\ell_{sr,real}$ or the total penetration length ℓ_{pd} .

To facilitate a comparison between the test results of the different series the mean total force for screw type A is used as a reference value, as shown in Table 4. The chosen comparison of indices also allows contrasting the results of the new test method with the minimum timber thickness determined by conventional insertion tests. A visualisation of this comparison is given in the bar chart in Figure 12. It shows the good correspondence between the results of the two test methods. Thence the method allows a direct evaluation of a screw's effect on the splitting behaviour by comparing it with the results of parallel tests involving reference screws whose influence on the splitting behaviour has already been established.

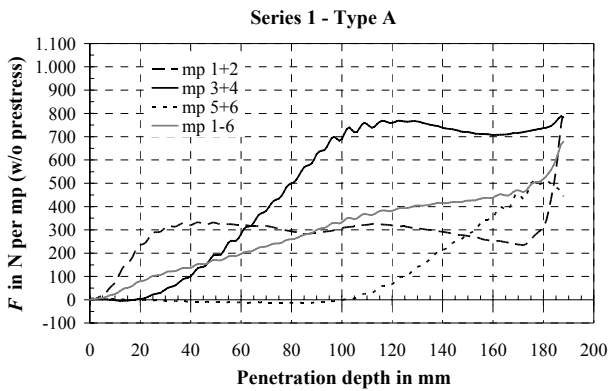

Figure 9: Forces at the measurement points (mp) over penetration depth for screw type A

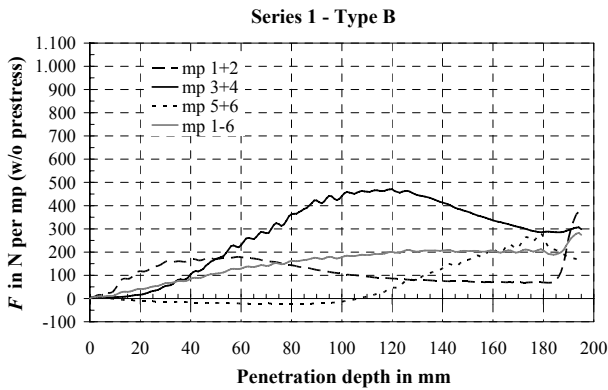

Figure 10: Forces at the measurement points (mp) over penetration depth for screw type B

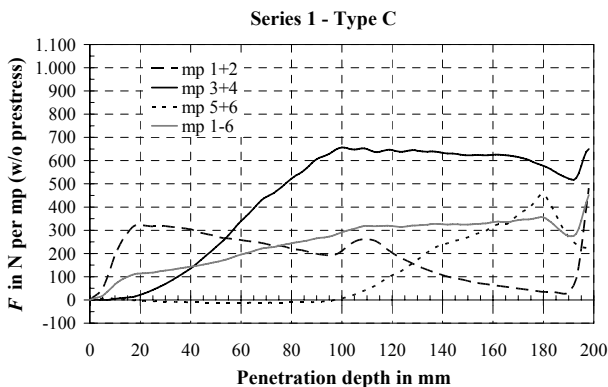

Figure 11: Forces at the measurement points (mp) over penetration depth for screw type C

Table 3: Specimen parameters for tests with screw types A, B and C, 8.0 x 200 mm, series 1 to 3

Series	Screw type	Number of tests		Specimen dimensions $d/b/h$ mm	ρ_{mean} kg/m ³
		absolute	usable		
1	A	10	9	24/80/180	453
	B	10	8		454
	C	10	7		460
2	A	14	9	24/80/200	378
	B	10	10		391
	C	10	10		387
3	A	13	6	24/80/200	506
	B	10	7		507
	C	10	8		502

Table 4: Results of test series 1 to 3

Series	Screw type	Mean total force		Minimum timber thickness	
		$F_{m,\text{tot}}$ N	Index %	t_{min} mm	Index %
1	A	1646	100	$10 \cdot d$	100
	B	886	54	$5 \cdot d$	50
	C	1466	89	$8 \cdot d$	80
2	A	1003	100	$10 \cdot d$	100
	B	595	59	$5 \cdot d$	50
	C	908	91	$8 \cdot d$	80
3	A	1689	100	$10 \cdot d$	100
	B	1013	60	$5 \cdot d$	50
	C	1576	93	$8 \cdot d$	80

■ Mean total force □ Minimum timber thickness

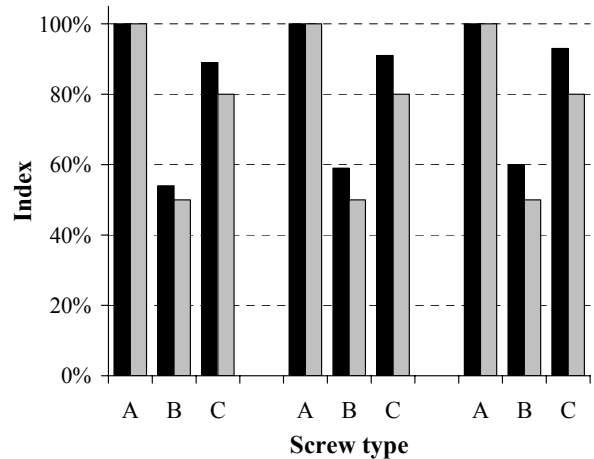

Figure 12: Bar chart of indices of mean total force $F_{m,\text{tot}}$ and minimum timber thickness t_{min} for Series 1 to 3

3.3 NUMERICAL MODELS

Knowing the size of the resulting split area is important to be able to evaluate the risk of splitting during the insertion process and hence to determine the required minimum timber thicknesses and minimum spacings, end and edge distances. Therefore a numerical model is developed to calculate the resulting crack area for differently spaced screws, for different end and edge distances as well as for different timber cross-sections. Furthermore material-specific influences on the splitting behaviour - like timber density, screw or annual ring orientation - are taken into consideration. For the numerical calculations the Finite Element program ANSYS 11.0 is used. Taking advantage of the symmetry conditions in the Finite Element model the timber member is modelled with volume elements. Figure 13 shows a schematic sketch of the Finite Element model. In order to model the insertion process an equivalent moving load is used. The tensile strength perpendicular to the grain, which represents a relevant factor for splitting, is simulated by using non-linear spring-elements whose material behaviour was determined on the basis of tests using CT specimens (Figure 14) carried out by Schmid [10]. Therefore the tests with CT-specimens were calculated by using a two-dimensional FE model. Because of the symmetry only half the specimen was modelled and the spring elements were placed in the crack area. The parameters of the springs' force-deflection curve were varied until the best fit between test results and FE-calculation of the CT-specimens was reached. Figure 15 shows a comparison of force-deflection curves of the test and of the FE-calculation for one CT-specimen (Fi02b). Altogether 47 CT-specimen made of *Picea abies* were used to calibrate the spring elements. The calculations resulted in the stress-deflection curve given in Figure 16.

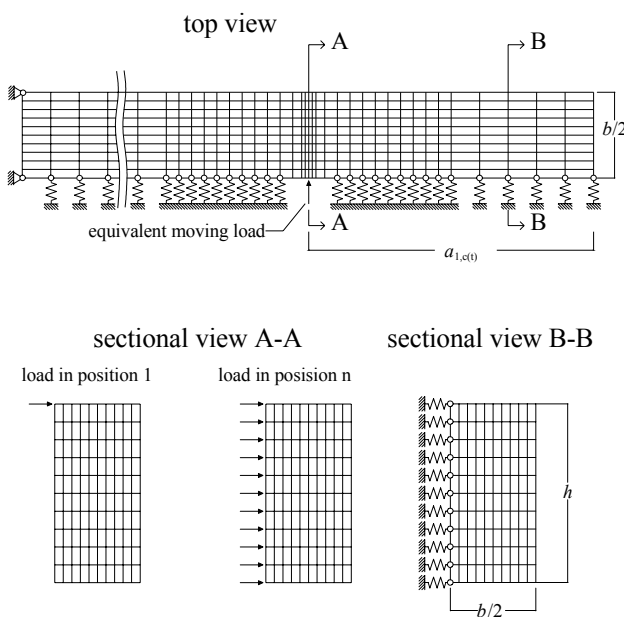

Figure 13: FE-model to calculate split areas, schematic sketch

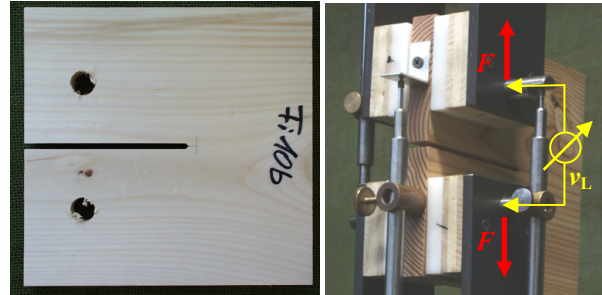

Figure 14: CT specimen and test set-up [10]

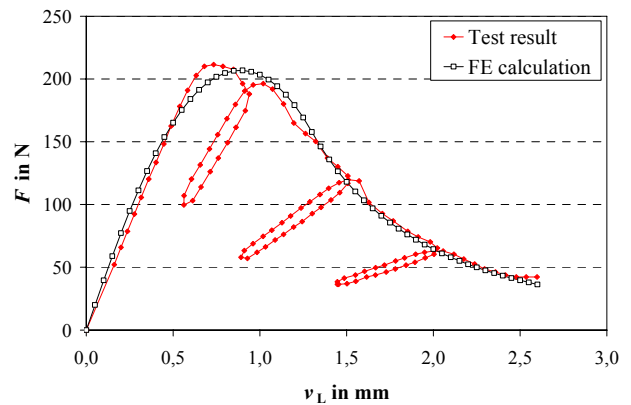

Figure 15: Force-deflection curve of one test with a CT-specimen (Fi02b) and of the corresponding calculation

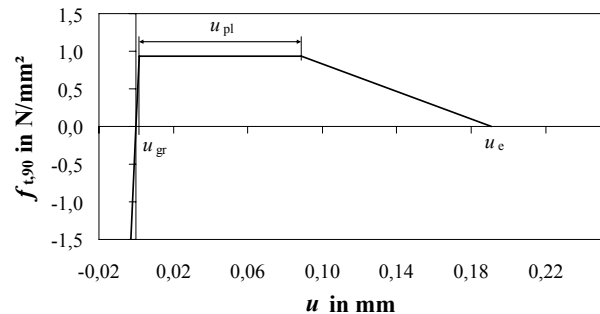

Figure 16: Stress-deflection curve of the spring elements

So far it is not possible to model the insertion process directly using the Finite Element Method. To solve this modelling problem the forces exerted on the timber during the insertion process should be determined on the basis of tests of the new method described in part 3.2. For this purpose the tests are simulated with a three dimensional Finite Element model (Figure 17). The insertion of the screw is modelled by an equivalent moving load (Figure 18). This load has to be determined iteratively. Therefore the function of the load $q(x_{st})$ is varied until the best fit between the force-penetration depth curves of calculations and test results is reached for each pair of measuring points. Figure 19 shows a comparison between calculated force-penetration depth curves and the test results for measuring points 1 to 6.

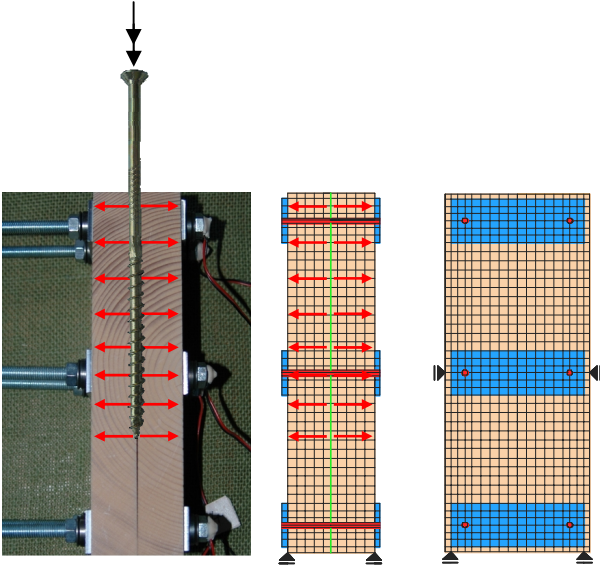

Figure 17: FE model of the tests, schematic presentation

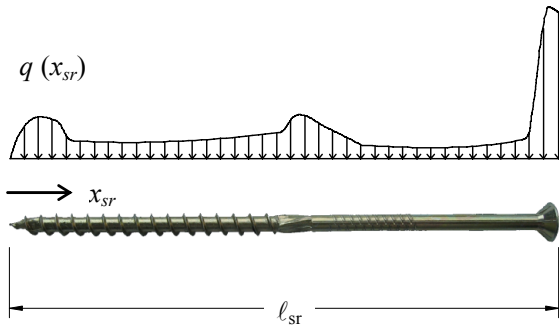

Figure 18: Equivalent moving load to simulate the insertion process, schematic presentation

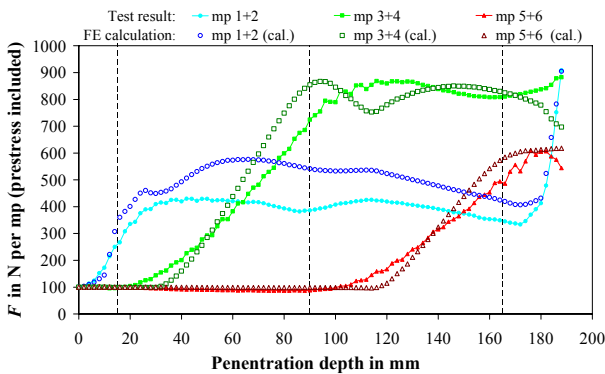

Figure 19: Comparison of calculated force-penetration depth curves and test results for measuring points 1 to 6

3.4 EXPERIMENTAL ANALYSIS OF SPLIT AREAS

The FE model (Figure 13) which is used to determine the split areas has to be calibrated and to be verified. To that purpose the cracks were visualized in insertion tests by dyeing the relevant areas. Lau [8] used this method in a similar way for tests with nails. For these tests the examined screw is driven into and through the timber. The screw head should be flush with the timber surface.

The screw should be inserted using a template to avoid an inclination of the screw. Friction effects reducing the splitting tendency should be eliminated. After the insertion the screw is unscrewed. The screw has produced a hole in the timber. This hole is sealed where the screw tip exits the specimen at the timber surface, e.g. by using a tape. Subsequently a low-viscosity dye is filled into the hole. The dye is distributed by capillary action into the cracks and colours the split area. After the dye has dried, the coloured split areas are made visible by opening the specimens along the split surface. At the opened specimen the size of the split area caused by the insertion of the screw can be quantified e.g. using a digital measuring projector. Figure 20 shows a typical split image of a specimen with black lines showing the borders of the split area.

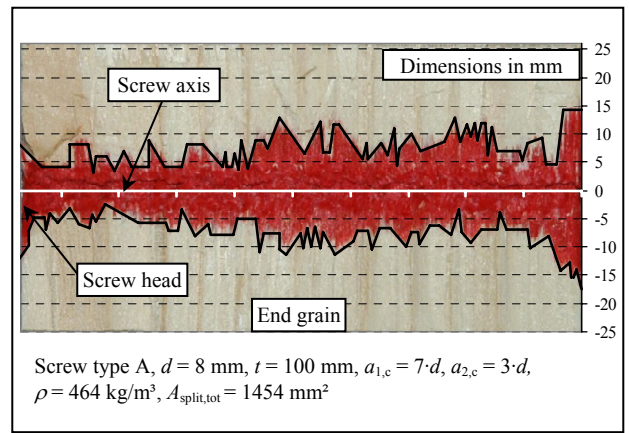

Figure 20: Opened specimen with red coloured split image, black lines indicating the borders of the split area

3.5 SIMULATION OF SPLIT AREAS

The FE model described in Figure 13 can be used to calculate the split area for an individual specimen. Therefore it is necessary to adjust the material properties of the volume elements and the spring elements regarding the specimen's parameters. Additionally the equivalent moving load has to be also adjusted. Influences on the equivalent moving load like density, insertion speed and the angle γ between the annual ring tangent and the screw's axis are covered by correction factors:

$$q_{\text{corr}}(x_{\text{Sr}}) = q(x_{\text{Sr}}) \cdot k_p \cdot k_r \cdot k_\gamma \cdot k_{\text{spl}} \quad (2)$$

where k_p = correction factor for density, k_r = correction factor for insertion speed, k_γ = correction factor for the angle between screw-axis and mean growth ring tangent, k_{spl} = split area calibration factor

On the basis of first test series with the new test method for screw-specific influences - presented in 3.2 - it was possible to determine the factors k_p and k_r :

$$k_p = \left(\frac{\rho}{\rho_{\text{ref}}} \right)^2 \quad (3)$$

where ρ = density of the specimen, ρ_{ref} = density of the specimen used to determine mean total forces

$$k_r = \left(\frac{U}{U_{\text{ref}}} \right)^{0,063} \quad (4)$$

where U = mean insertion speed (rpm), U_{ref} = screw insertion speed (rpm) at the tests for mean total forces

An exact calculation of k_r is only possible if the rotation speed can be measured e.g. using a screw-testing machine with a known constant and load-independent rotation speed. For customary electric screw drivers the rotation speed under loading is not known and depends on the torsional resistance.

The tests performed with specimens of sawn timber are not sufficient to determine the influences of the angle γ between the screw axis and the growth ring tangent. In the case of these specimens the angle γ varied between circa 0° and 90° depending on the position in specimen height. For an explicit analysis of the influence of γ special specimens of glued laminated timber produced from one lamella in the laboratory (Figure 21) will be used. For these specimens the angle γ is constant over the height. As long as k_r is not identified exactly for a screw type by these tests $k_r = 1,0$ is hypothesised.

The factor k_{spl} is used to cover further influences and is determined in the process of the model calibration. For the calibration all known parameters and correction factors are calculated and included in the model. By comparing the calculated split areas with the result of calibration test series the factor k_{spl} can be derived.

Because of the still existent imprecision of the factors k_r and k_γ the correction factors k_r , k_γ and k_{spl} were merged to form the factor k_{corr} for the calculations presented here. k_{corr} is determined by using calibration test series as shown in Equation (5).

$$k_{\text{corr}} = k_r \cdot k_\gamma \cdot k_{\text{spl}} = 1,35 \cdot \left(\frac{\rho_{\text{ref}}}{\rho} \right)^{0,8} \quad (5)$$

With Equation (5) the equivalent moving load (2) can be calculated as following:

$$q_{\text{corr}}(x_{\text{Sr}}) = q(x_{\text{Sr}}) \cdot k_p \cdot k_{\text{corr}} \quad (6)$$

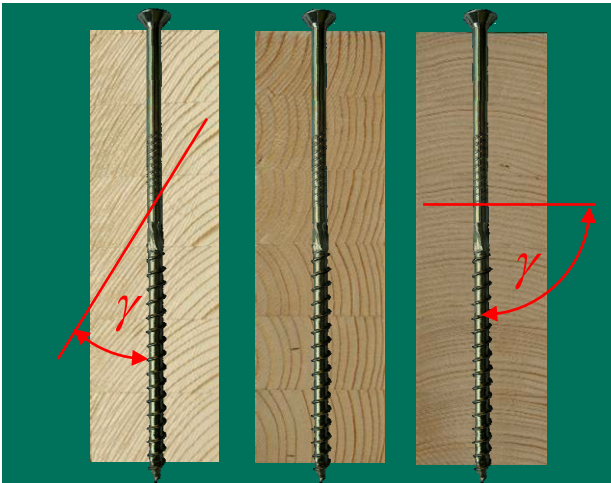

Figure 21: Specimens to determine the influence of γ

Figure 22 illustrates the resulting split area for one specimen (B.1-01) in comparison to the simulated split area. The results of test and simulation correspond in quality and quantity.

To verify the calculation model calculated split areas are compared with test results. Figure 23 shows test results over simulated split areas for three series and three types of screws in each series. The simulated crack areas mostly proved to correspond with the test results.

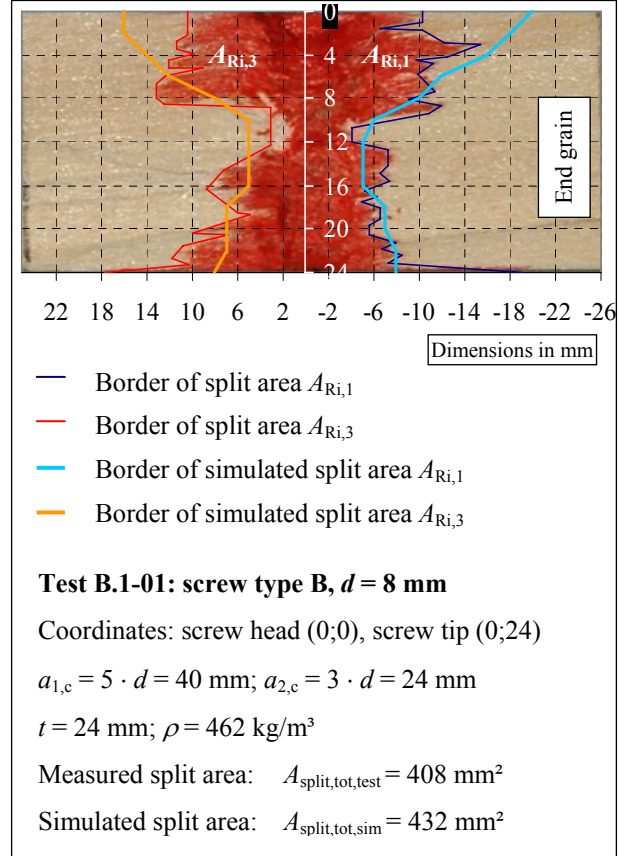

Figure 22: Split area of test and of calculation for one specimen

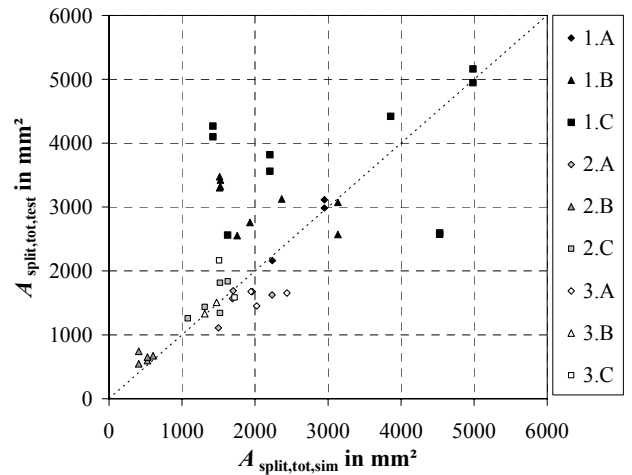

Figure 23: Measured split areas of tests vs. simulated split areas

4 CONCLUSIONS

To estimate the splitting behaviour of timber during the insertion process a new calculation method was developed. It represents a combination of a FE calculation and a new test method for determining splitting forces. The FE model allows the calculation of the resulting crack area for screws in different end distances as well as for different cross-sections of timber.

For this, the specific influences of material properties on the splitting behaviour are taken into consideration. In the Finite Element model the tensile strength perpendicular to the grain that represents a relevant factor for splitting was simulated by using non-linear spring-elements whose material behaviour was determined on the basis of tests using CT specimens.

In order to determine the fastener-specific influences on the splitting behaviour a new method was developed for measuring forces affecting the member perpendicular to the grain during the insertion process. This method also allows a direct evaluation of a screw's effect on the splitting behaviour by contrasting it with the results of parallel tests involving reference screws whose influence on the splitting behaviour has already been established. For the calibration and verification of the model the crack area was visualized in insertion tests by means of dyeing the relevant areas. The simulated crack areas mostly proved to correspond with the test results.

The model allows a calculation of required timber thickness, end and edge distances for different screws as well as an estimation of expected splitting phenomena. Furthermore the methods allow the evaluation of the splitting behaviour on basis of objective test results or calculations. This reduces the effort of conventional insertion tests and offers a basis for a realistic calculation of the load carrying capacity of joints in the case of failure by splitting.

In the continuation of the research project the parameters influencing the splitting behaviour like e.g. the angle between screw axis and tangent to the annual rings will be determined in greater detail. Besides the influences of the angle between screw axis and grain direction will be examined. In addition, parameters to facilitate the evaluation of the splitting behaviour and their limits (e.g. limits for the dimension of split areas) will be derived.

REFERENCES

- [1] DIN 1052:2008-12: Entwurf, Berechnung und Bemessung von Holzbauwerken – Allgemeine Bemessungsregeln und Bemessungsregeln für den Hochbau
- [2] EN 1995-1-1:2008-09: Eurocode 5: Design of timber structures – Part 1-1: General – Common rules and rules for buildings.
- [3] Blaß H. J., Uibel T.: Spaltversagen von Holz in Verbindungen - Ein Rechenmodell für die Rissbildung beim Eindrehen von Holzschrauben. *Karlsruher Berichte zum Ingenieurholzbau*, Band 12, Universitätsverlag Karlsruhe, Germany, 2009, ISBN 978-3-86644-312-915.
- [4] Blaß H. J., Bejtka I., Uibel T.: Tragfähigkeit von Verbindungen mit selbstbohrenden Holzschrauben mit Vollgewinde. *Karlsruher Berichte zum Ingenieurholzbau*, Band 4, Universitätsverlag Karlsruhe, Germany, 2006
- [5] Ehlbeck, J.; Görlacher, R.: Mindestabstände bei Stahlblech-Holz-Nagelverbindungen. Forschungsbericht, Versuchsanstalt für Stahl, Holz und Steine, Abteilung Ingenieurholzbau, Universität Karlsruhe, Germany, 1982
- [6] Ehlbeck, J.; Siebert, W.: Ermittlung der Mindestholzabmessungen und Mindestnagelabständen bei Nagelverbindungen mit europäischem Douglasienholz. Forschungsbericht, Versuchsanstalt für Stahl, Holz und Steine, Abteilung Ingenieurholzbau, Universität Karlsruhe, Germany, 1988
- [7] Kevarinmäki, A.: Nails in spruce – splitting sensitivity, end grain joints and withdrawal strength, In *Proceedings. CIB-W18 Meeting 2005*, Karlsruhe, Germany, 2005, Paper 38-7-6J
- [8] Lau, P.W.C.; Tardiff, Y.: Progress report: Cracks produced by driving nails into wood – effects of wood and nail variables. Forintek Canada Corp., 1987
- [9] Marten, G.: Spalten und Tragfähigkeit von Nagelverbindungen, Fortschritte und Forschung im Bauwesen, Reihe D, *Berichte des Beirats für Bauforschung beim Bundesminister für Wohnungsbau*, Heft 9, Versuche für den Holzbau, , Germany, 1953, S. 55-89
- [10] Schmid, M.: Anwendung der Bruchmechanik auf Verbindungen mit Holz. *Berichte der Versuchsanstalt für Stahl, Holz und Steine*, Universität Karlsruhe (TH), Karlsruhe, Germany, 2002.
- [11] Uibel T., Blaß H. J.: Spaltverhalten von Holz beim Eindrehen von selbstbohrenden Holzschrauben. In *Doktorandenkolloquium, Holzbau Forschung und Praxis, Stuttgart 2008*, pages 135 - 142, Institut für Konstruktion und Entwurf, Universität, Stuttgart, Germany 2008
- [12] Uibel T.: Beurteilung der Spaltgefahr beim Eindrehen von selbstbohrenden Holzschrauben. In *15. Internationales Holzbau-Forum Garmisch-Partenkirchen, Aus der Praxis - Für die Praxis*, Band 1, Fraunhofer IRB Verlag, Stuttgart, Germany 2009